



#1031



LISTA DE PRECIOS 2022



RUGO[®]
Calidad en Válvulas



RUGO
CALIDAD EN VALVULAS

CORPORATIVO

PLANTA



POLÍTICA

POLÍTICA PARA ACEPTAR DEVOLUCIÓN DE MERCANCÍA

I. TODA DEVOLUCIÓN DE MERCANCÍA DE PRODUCTOS CON DEFECTO DE FÁBRICA SE ACEPTARÁ CUMPLIENDO LAS SIGUIENTES CONDICIONES:

- 1 • Verificación de marca**
- 2 • Verificar que sea defecto de fabricación dentro del tiempo de garantía y no mala instalación o daño por causas atribuidas al consumidor.**
- 3 • Devoluciones en mal estado genera nota de crédito.**

II. TODA DEVOLUCIÓN DE MERCANCÍA EN BUEN ESTADO SE ACEPTARÁ CUMPLIENDO LAS SIGUIENTES CONDICIONES:

- 1 • Deberá ser aprobada por jefatura de ventas, gerencia o dirección comercial. En caso de ser autorizada se generará un cargo del 15% del valor del producto, además de los cargos del flete.**
- 2 • El producto debe de estar completo con todos sus componentes; así como su empaque en buen estado (no rayado, raspado, roto, mojado, maltratado, mutilado, etc.)**
- 3 • En caso de que las cajas estén dañadas o maltratadas tendran un cargo de \$15.00 M.N. cada una.**

ICONOGRAFÍA



Indica que cumple con norma mexicana, según corresponda



Indica que cumple con norma oficial mexicana, según corresponda



Indica que cumple con norma oficial mexicana, según corresponda



Producto ahorrador de agua



Producto ecológico



País en donde fue fabricado



País en donde fue fabricado



País en donde fue fabricado



Indica que el maneral de un producto gira 360°



Indica que el maneral de un producto gira 1/4 de vuelta



Indica que el maneral de un producto gira 1/4 de vuelta



Sistema anticucaracha



Facilidad para la limpieza

ÍNDICE ALFANUMÉRICO

004-FM.....	1	19-H.....	25	23-IR.....	18	24-Q.....	16
005-FM.....	1	19-I.....	25	23-IRR.....	18	24-Q DESPIECE.....	103
006-FM.....	1	19-IB.....	25	23-IRS.....	18	24-QL.....	16
008-FM.....	1	19-IBS.....	25	23-MCC.....	14	24-QR.....	16
009-FM.....	1	19-ICS.....	25	23-MM.....	14	24-QS.....	16
010-FM.....	1	19-IS.....	25	23-MQ.....	14	24-R.....	21
091-RC.....	24	19-LA.....	25	23-MRC.....	19	24-RM.....	21
1.....	77	19-LG.....	25	23-MTC.....	14	24-RMM.....	21
1-GC.....	77	19-R.....	26	23-MTL.....	14	24-SP.....	21
10-B.....	10	19-SC.....	26	23-MTS.....	14	24-T.....	21
10-ED.....	9	19-VA.....	26	23-PB.....	19	24-TD.....	21
10-EI.....	9	19-VAC.....	26	23-PHD.....	19	24-TG.....	21
10-EIR.....	9	19-VC.....	26	23-PR.....	19	24-TH.....	16 Y 21
10-LF.....	10 Y 30	19-VCC.....	26	23-RC.....	19	24-TL.....	21
10-PPF.....	10	19-VH.....	26	23-RD.....	19	24-TP.....	21
10-PTF.....	11	19-VHC.....	26	23-RDG.....	19	24-TR.....	22
10-R.....	11	19-VR.....	26	23-RI.....	19	24-TS.....	22
10-RF.....	11 Y 29	19-VRC.....	26	23-TLS.....	14	24R-01.....	95
10-TB.....	9	19-VSR.....	27	23-TM.....	19	25.....	65
11-B.....	10	2.....	78	23-TMO.....	19	25-B (1/2"X3/4"X40CM) BOILER.....	70
11-BA.....	10	2-A.....	78	23-TMS.....	20	25-B (1/2"X3/4"X60CM) BOILER.....	70
11-E.....	11	2-AL.....	78	24-BO.....	22	25-B (1/2"X3/4"X80CM) BOILER.....	70
11-EP.....	11	2-AS.....	78	24-BP.....	22	25-B (3/4"X3/4"X40CM) BOILER.....	70
11-EPF.....	11	2-CI.....	85	24-BT.....	22	25-B (3/4"X3/4"X60CM) BOILER.....	70
11-P.....	11	2-CL.....	85	24-CC.....	22	25-B (3/4"X3/4"X80CM) BOILER.....	70
11-PF.....	11	2-D.....	78	24-CL.....	16	25-BA (1/2"X3/4"X60CM) BOILER.....	70
11-PT.....	11	2-G.....	78	24-CP.....	20	25-BA (3/4"X3/4"X60CM) BOILER.....	70
11-PTF.....	10 Y 30	2-GC.....	78	24-CRB.....	23	25-BA (3/4"X3/4"X80CM) BOILER.....	70
11-R.....	10 Y 31	2-HI.....	85	24-CS.....	23	25-BHH (1/2"X1/2"X60CM) BOILER.....	70
11-RF.....	10	2-HL.....	85	24-CT.....	16	25-BHH (1/2"X1/2"X80CM) BOILER.....	70
11-RS.....	10 Y 31	2-I.....	78	24-CV.....	20	25-BMH (1/2"X1/2"X80CM) BOILER.....	70
11-TR.....	13	2-IE.....	78	24-I.....	16 Y 20	25-CC.....	65
11-U.....	13	2-IM.....	78	24-IB.....	23	25-E.....	65
12-IL.....	12	2-IVV.....	79	24-IBL.....	23	25-GN (3/8"X3/8"X1000CM) USO GENERAL.....	71
12-PA.....	12	2-R.....	79	24-ID.....	23	25-GN (3/8"X3/8"X100CM) GAS.....	70
12-PR.....	12	2-RI.....	79	24-IG.....	23	25-GN (3/8"X3/8"X150CM) GAS.....	70
13-AC.....	12	20-A.....	17	24-IL.....	16 Y 20	25-GN (3/8"X3/8"X200CM) GAS.....	70
13-I.....	12	20-C.....	17	24-IMM.....	20	25-GN (3/8"X3/8"X300CM) USO GENERAL.....	71
13-IL.....	12	20-LP.....	17	24-IP.....	23	25-GN (3/8"X3/8"X400CM) USO GENERAL.....	71
13-IP.....	12	20-MC.....	14	24-IP DESPIECE.....	103	25-GN (3/8"X3/8"X500CM) USO GENERAL.....	71
13-PP.....	12	20-P.....	17	24-IR.....	23	25-GN (3/8"X3/8"X60CM) GAS.....	70
13-R.....	12	20-R.....	17	24-IS.....	23	25-GN (5/16"X5/16"X1000CM) USO GENERAL.....	71
14.....	13	20-RCC.....	17	24-K.....	16	25-GN (5/16"X5/16"X100CM) GAS.....	70
14-PR.....	13	20-RPC.....	17	24-KL.....	16	25-GN (5/16"X5/16"X150CM) GAS.....	70
16-B.....	28	20-RVC.....	17	24-LC.....	23	25-GN (5/16"X5/16"X200CM) GAS.....	70
16-BB.....	29	200-L.....	89	24-MC.....	14	25-GN (5/16"X5/16"X300CM) USO GENERAL.....	71
16-BC.....	28	21-P.....	17	24-MCC.....	14	25-GN (5/16"X5/16"X400CM) USO GENERAL.....	71
16-BP.....	29	21-IP.....	64	24-MCS.....	15	25-GN (5/16"X5/16"X500CM) USO GENERAL.....	71
16-I.....	28	21-PH.....	17	24-ML.....	24	25-GN (5/16"X5/16"X60CM) GAS.....	70
16-Q.....	28	210-H.....	89	24-MP.....	15	25-GNA (3/8"X3/8"X100CM) GAS.....	71
16-R.....	28	22-CL.....	18	24-MR.....	20	25-GNA (3/8"X3/8"X150CM) GAS.....	71
16-RC.....	28	22-IP.....	64	24-MS.....	15	25-GNA (3/8"X3/8"X200CM) GAS.....	71
16-SE.....	28	220-H.....	89	24-MTA.....	15	25-GNA (3/8"X3/8"X300CM) GAS.....	71
16-T.....	29	23-CRE.....	18	24-MTC.....	15	25-GNA (3/8"X3/8"X500CM) GAS.....	71
17-T.....	29	23-CRM.....	18	24-MTL.....	15	25-GNA (5/16"X5/16"X100CM) GAS.....	71
19-A.....	24	23-I.....	18	24-MTS.....	15	25-GNA (5/16"X5/16"X150CM) GAS.....	71
19-AC.....	24	23-IB.....	18	24-P.....	20	25-GNA (5/16"X5/16"X200CM) GAS.....	71
19-FCS.....	24	23-IE.....	18	24-PB.....	20	25-GNA (5/16"X5/16"X300CM) GAS.....	71
19-GH.....	25	23-IL CARTUCHO CERÁMICO.....	18	24-PP.....	20	25-GNA (5/16"X5/16"X500CM) GAS.....	71
19-GRC.....	25	23-IL CIERRE DE COMPRESIÓN.....	16	24-PA.....	24	25-GNA (5/16"X5/16"X60CM) GAS.....	71

ÍNDICE ALFANUMÉRICO

25-GNI (3/8"X3/8"X1000CM) USO GENERAL.....	71	29-T.....	30	39-IM.....	36
25-GNI (3/8"X3/8"X100CM) USO GENERAL.....	71	29-U.....	32	39-IR.....	37
25-GNI (3/8"X3/8"X150CM) USO GENERAL.....	71	3.....	79	39-IS.....	37
25-GNI (3/8"X3/8"X200CM) USO GENERAL.....	71	3-AB.....	79	39-Q.....	37
25-GNI (3/8"X3/8"X300CM) USO GENERAL.....	71	3-ABC.....	79	4-B.....	80
25-GNI (3/8"X3/8"X400CM) USO GENERAL.....	71	3-B.....	79	4-CF.....	79
25-GNI (3/8"X3/8"X500CM) USO GENERAL.....	71	30.....	31	4-FF.....	79
25-GNI (3/8"X3/8"X60CM) USO GENERAL.....	71	30-B.....	31	4-N.....	79
25-GNI (5/16"X5/16"X1000CM) USO GENERAL.....	71	30-C.....	32	40-CR.....	35
25-GNI (5/16"X5/16"X100CM) USO GENERAL.....	71	30-L.....	32	40-E.....	36
25-GNI (5/16"X5/16"X150CM) USO GENERAL.....	71	30-LER.....	32	40-P.....	35
25-GNI (5/16"X5/16"X200CM) USO GENERAL.....	71	30-LES.....	32	40-Q.....	36
25-GNI (5/16"X5/16"X300CM) USO GENERAL.....	71	30-LPR.....	32	40-QL.....	36
25-GNI (5/16"X5/16"X400CM) USO GENERAL.....	71	30-LPS.....	32	41-CR.....	36
25-GNI (5/16"X5/16"X500CM) USO GENERAL.....	71	30-PA.....	32	41-E.....	37
25-GNI (5/16"X5/16"X60CM) USO GENERAL.....	71	30-PR.....	32	41-P.....	36
25-I.....	65	30-T.....	32	41-Q.....	37
25-IA.....	65	31.....	32	41-QL.....	37
25-IC.....	65	31-PR.....	32	44-A.....	43
25-ICE.....	65	32-I.....	36	44-AB.....	43
25-IG.....	66	32-PVC.....	37	44-AC.....	43
25-IR 13 X 10 MM.....	66	33-I.....	37	44-AD.....	43
25-IR 13 X 13 MM.....	66	34-I.....	35	44-AE.....	44
25-MA (1/2"X1/2"X40CM) LAV. Y FREG.....	69	34-MC.....	33	44-AF.....	44
25-MA (1/2"X1/2"X55CM) LAV. Y FREG.....	69	34-MCC.....	33	44-AG.....	44
25-MA (1/2"X1/2"X100CM) LAV. Y FREG.....	69	34-MCO.....	33	44-AM.....	44
25-ME (1/2"X1/2"X100CM) LAV. Y FREG.....	68	34-MQ.....	33	44-AN.....	44
25-ME (1/2"X1/2"X55CM) LAV. Y FREG.....	68	34-MS.....	33	44-AP.....	44
25-ME (1/2"X1/2"X60CM) LAV. Y FREG.....	68	34-MT.....	33	44-AR.....	44
25-ME (1/2"X1/2"X70CM) LAV. Y FREG.....	68	35-I.....	35	44-AZ.....	44
25-ME (1/2"X1/2"X80CM) LAV. Y FREG.....	68	36-AC.....	34	44-BB.....	44
25-ME (3/8"X1/2"X40CM) LAV. Y FREG.....	68	36-AO.....	34	44-BC.....	44
25-ME (3/8"X1/2"X55CM) LAV. Y FREG.....	68	36-I.....	34	44-CA.....	45
25-MET (1/2"X1/2"X1/2"X55CM) LAV. Y FREG.....	68	36-IAN.....	34	44-CB.....	45
25-MX (3/8"X1/2"X55CM) LAV. Y FREG.....	69	36-ICM.....	34	44-CC.....	45
25-V (1/2"X1/2"X40CM) LAV. Y FREG.....	69	36-ICR.....	34	44-CCE.....	45
25-V (1/2"X1/2"X40CM) LAV. Y FREG.....	69	36-IG.....	34	44-CM.....	45
25-V (1/2"X1/2"X55CM) LAV. Y FREG.....	69	36-IP.....	34	44-CP.....	45
25-V (1/2"X1/2"X55CM) LAV. Y FREG.....	69	36-IS.....	34	44-CR.....	45
26.....	33	36-MM.....	33	44-CRG.....	45
26-A.....	33	36-PF.....	34	44-DCA.....	45
26-T.....	33	36-PM.....	34	44-DCB.....	45
28-B.....	29	36-R.....	34	44-DCC.....	45
28-D.....	31	36-RCC.....	34	44-DCP.....	45
28-L.....	31	36-THS.....	34	44-DRA.....	46
28-LC.....	31	37-MM.....	33	44-DRB.....	46
28-PT.....	31	37-MPL.....	33	44-DRC.....	46
28-PTF.....	29	38-EC.....	35	44-DRP.....	46
29.....	29	38-GCE.....	36	44-F.....	46
29-B.....	29	38-I.....	36	44-G.....	46
29-BA.....	29	38-IC.....	35	44-GA.....	46
29-C.....	30	38-IG.....	35	44-GO.....	46
29-D.....	31	38-IM.....	35	44-GP.....	46
29-DA.....	31	38-IR.....	36	44-GS.....	46
29-H.....	30	38-IS.....	36	44-GSS.....	46
29-L.....	30	38-MT.....	35	44-H.....	46
29-P.....	30	38-Q.....	36	44-HC.....	47
29-PL.....	30	39-EC.....	35	44-I.....	47
29-R.....	30	39-I.....	37	44-IB.....	47
29-RF.....	30	39-IC.....	35	44-IBE.....	47

ÍNDICE ALFANUMÉRICO

44-IC.....	47	46-AI.....	53	67-ME (1/2"X7/8"X50CM) W.C.....	68
44-IO.....	47	46-AIC.....	53	67-ME (1/2"X7/8"X60CM) W.C.....	68
44-M.....	47	46-AR.....	53	67-ME (7/8"X7/8"X35CM) W.C.....	68
44-MC.....	47	46-P.....	53	67-ME (7/8"X7/8"X50CM) W.C.....	68
44-ME.....	47	46-Z.....	53	67-MF (1/2"X7/8"X35CM) W.C.....	68
44-N.....	47	47-C.....	53	67-MF (3/8"X7/8"X40CM) W.C.....	68
44-P.....	48	47-CZ.....	53	67-V (1/2"X7/8"X35CM) W.C. /TUERCAS LATÓN-PLÁSTICO.....	69
44-PC.....	48	47-P.....	53	67-V (7/8"X7/8"X35CM) W.C. /TUERCAS LATÓN-PLÁSTICO.....	69
44-PCC.....	48	47-PRB.....	53	67-V (7/8"X7/8"X35CM) W.C. /TUERCAS PLÁSTICO.....	69
44-PF.....	48	47-PRC.....	53	67-V (7/8"X7/8"X35CM) W.C. /TUERCAS PLÁSTICO.....	69
44-PG.....	48	48-CHP.....	53	69.....	65
44-PGS.....	48	48-EHP.....	53	69-R.....	65
44-PH.....	48	48-KAH.....	54	69-RC.....	85
44-PO.....	48	48-RHA.....	54	69-T.....	65
44-R.....	48	48-RHP.....	54	7-C.....	2
44-RC.....	48	48-RHR.....	54	7-F.....	7
44-RR.....	49	48-TSH.....	54	7-FC.....	7
44-S.....	49	5-C.....	7	7-FL.....	7
44-SCB.....	49	50.....	74	7-FPC.....	7
44-SL.....	49	50 ASIENTO CAMBIABLE.....	74	7-FPL.....	7
44-SRB.....	49	50-P.....	74	7-FPT.....	7
44-T.....	49	50-PA.....	74	7-IM.....	2
44-TA.....	49	50-PAB.....	74	7-LC.....	3
44-TB.....	49	50-PB.....	74	7-LCC.....	3
44-TC.....	49	52.....	74	7-LCCS.....	3
44-TMC.....	49	52-DBA.....	74	7-LS.....	3
44-TN.....	50	52-DLT.....	74	7-MC.....	2
44-TPC.....	50	52-P.....	74	7-MQ.....	2
44-TRC.....	50	55.....	76	7-MS.....	2
44-UCA.....	50	55-I.....	76	70.....	84
44-UCB.....	50	55-P.....	76	70-C.....	84
44-UCC.....	50	57.....	76	70-L.....	84
44-URA.....	50	58.....	76	70-P.....	84
44-URB.....	50	58-A.....	77	70-V.....	84
44-URC.....	50	58-AG.....	77	71.....	84
44-V.....	50	58-T.....	76	71-LV.....	84
44-VS.....	50	6-LC.....	2	71-V.....	84
44-WG.....	50	6-LS.....	2	72.....	75
44-WGS.....	50	6-P.....	3	72-P.....	75
45.....	50	60-I.....	75	72-PAD.....	75
45-B.....	50	60-IP.....	75	72-PBP.....	75
45-BA.....	51	60-IPP.....	76	73.....	80
45-BAI.....	51	60-KO.....	76	73-A.....	114
45-BC.....	51	60-PL.....	76	73-I.....	80
45-BEA.....	51	60-R.....	76	74.....	80
45-BF.....	51	60-RL.....	76	74-A.....	80
45-BL.....	51	61.....	77	74-I.....	80
45-BR.....	51	61-FT.....	77	75-AH.....	80
45-BRA.....	51	62.....	77	75-BH.....	80
45-BRF.....	51	65.....	84	76.....	112
45-BRS.....	51	66.....	8 Y 66	76-A.....	119
45-CF.....	52	6-B.....	66	79.....	80
45-F.....	52	66-BS.....	66	79-H.....	80
45-I.....	52	66-C.....	8 Y 66	79-N.....	80
45-LB.....	52	66-G.....	66	79-V.....	81
45-PC.....	52	66-MS 13 X 13 MM.....	66	7R-01.....	94
45-R.....	52	66-MS 13 X 22 MM.....	66	8-BM.....	3
46 102 X 102 MM.....	52	67-MA (1/2"X7/8"X35CM) W.C.....	69	8-BT.....	3
46 146 X 146 MM.....	52	67-MA (7/8"X7/8"X35CM) W.C.....	69	8-CR.....	3
46-AF.....	52	67-ME (1/2"X7/8"X35CM) W.C.....	68	8-CRF.....	3

ÍNDICE ALFANUMÉRICO

8-D.....	3	81-UTL.....	117	97-THR.....	119	B98-RC.....	94
8-G.....	4	82.....	114	97-TM.....	83 Y 118	BOT-01 GRIS.....	89
8-GF.....	4	83.....	115	97-TPH.....	83 Y 118	BR-1.....	97
8-I.....	4	84-BR.....	115	98.....	92	BR-14.....	102
8-I DESPIECE.....	103	84-BRN.....	115	98-CC.....	92	BRC-10.....	98
8-IC CARTUCHO CERÁMICO.....	4	84-LR.....	115	98-CE.....	92	BRI-02.....	94
8-IC CIERRE DE COMPRESIÓN.....	4	86.....	115	98-E.....	92	BRI-14.....	94
8-ICC.....	4	86-DA.....	115	98-EE.....	93	BRI-98.....	94
8-ID.....	4	87-L.....	115	98-IN.....	93	BRM-F1.....	102
8-IE.....	4	89-L.....	115	98-N.....	93	BRM-F3.....	102
8-IG.....	4	89-LTA.....	115	98-RC.....	93	BRM-L1.....	100
8-IGN.....	4	8B-02.....	94	99-AB.....	111	BS-18.....	60
8-IL.....	5	8C-02.....	95	99-ABR.....	111	BS-24.....	60
8-IM.....	5	8R01P.....	96	100-CP.....	81	BSA-01.....	60
8-IN.....	5	8R-02.....	95	100-I.....	82	BT-38.....	75
8-IP.....	5	8R-03.....	100	100-IB.....	114	BT-48.....	75
8-IP DESPIECE.....	103	8R-11.....	96	100-IS.....	82	C-01.....	86
8-IPF.....	5	8R-12.....	95	100-P.....	81	C-02.....	86
8-IPO.....	5	8R-16.....	40	100-PS.....	82	C-03.....	86
8-IPP.....	5	8R-17.....	40	100-RR.....	82	C-04.....	86
8-IR.....	5	8R-18.....	40	100-SR.....	82	C-05.....	86
8-IS.....	5	8R-22.....	92	101.....	79 Y 114	C-06.....	86
8-LC.....	5	8R-25.....	92	102-IR.....	82	C-07.....	86
8-LS.....	5	8R-40.....	95	102-IS.....	82	C-09.....	86
8-MF.....	6	9-DT.....	8	103-LM.....	15	C-10.....	86
8-P.....	6	9-ED.....	8	104-FM.....	1	C-12.....	86
8-PP.....	6	9-EDC.....	8	105-LM.....	15	C-14.....	86
8-R.....	6	9-EDR.....	8	106-LM.....	15	C-17.....	86
8-RB.....	6	9-EI.....	8	107-FM.....	1	C-26.....	86
8-RBL.....	6	9-EIC.....	8	108-RM.....	33	C-28.....	86
8-RG.....	6	9-EIR.....	9	109-FM.....	1	C-36P.....	42
8-RP.....	6	9-I.....	6	111-FM.....	1	C24-MC.....	101
8-ST.....	2	9-IC.....	6	151-B.....	53	C34MC.....	100
8-TC.....	2	9R-13.....	100	190-RC.....	24	CA-01.....	13
80-B.....	112	9-TS.....	9	190-RP.....	24	CAN.....	87
80-E.....	112	9-TSE.....	9	190-RS.....	24	CAP-01.....	87
81.....	112	90-D.....	115	502-RH.....	15	CC.....	119
81-A.....	113	90-P.....	116	614-RA.....	2	CCE.....	119
81-AP.....	113	91-L.....	116	A-BA.....	61	CC-01.....	87
81-APL.....	113	91-LTA.....	116	A-BB.....	61	CC-16T.....	91
81-AR.....	119	91-P.....	116	A-BC.....	61	CCLM.....	88
81-EC.....	112	92.....	81	A-I.....	87	CEB.....	88
81-EP.....	112	93.....	81	AMF.....	97	CEBP.....	88
81-ETA.....	112	93-C.....	81	ASI-05.....	73	CECO.....	88
81-HP.....	113	94-B.....	81 Y 114	B-83.....	115	CEDL.....	88
81-HPL.....	113	94-BH.....	81 Y 114	B200-L.....	89	CEL.....	88
81-LTA.....	113	94-BL.....	81 Y 114	B21.....	78	CELM.....	88
81-ML.....	113	96-A.....	114	B210-H.....	89	CELP.....	88
81-MTA.....	113	96-AM.....	114	B220-H.....	89	CEP.....	88
81-P.....	112	96-B.....	117	B26P.....	33	CEPD.....	88
81-PHS.....	113	96-C.....	117	B81-U.....	83 Y 116	CH-34M.....	101
81-PMS.....	113	96-CTA.....	117	B8R-05.....	98	CH-37M.....	101
81-PTA.....	112	96-PF.....	117	B94-B.....	81 Y 114	CH-98.....	42
81-RM.....	119	96-PFL.....	117	B98.....	93	CH-C.....	43
81-U.....	83 Y 116	96-PH.....	117	B98-CC.....	93	CH-G.....	43
81-UAD.....	116	96-PM.....	118	B98-CE.....	93	CH-GC.....	43
81-UAL.....	116	96-PP.....	118	B98-E.....	93	CH-GS.....	43
81-UAP.....	116	97-N.....	83 Y 118	B98-EE.....	93	CH-I.....	85
81-UL.....	83 Y 117	97-NR.....	83 Y 118	B98-IN.....	93	CH-P.....	85
81-UPP.....	117	97-RB.....	83 Y 118	B98-N.....	94	CHMC.....	38

ÍNDICE ALFANUMÉRICO











CHME.....	38	GA-94C.....	58	KIT-F4.....	72	NCM01.....	118 y 119
CHP-05.....	85	GA-96C.....	56	KIT-F5.....	72	NMR.....	118 y 119
CHP-10.....	85	GD-ABA.....	59	KIT-F8.....	73	NMT.....	118
CHP-15.....	85	GM-01.....	59	KIT-F9.....	73	P-126.....	58
CHR.....	101	GOG-03.....	89	KIT-L1.....	73	PIE-TD DOBLE.....	119
CHRC.....	101	GOL-01.....	89	KIT-L2.....	73	PIE-TD.....	119
CHTEC.....	38	GOT-02.....	89	KIT-L3.....	73	PMF1.....	104
CHTEE.....	38	HE.....	77	KIT-L4.....	73	PMF3.....	104
CMT-01.....	87	IE-39I.....	98	KIT-M1.....	73	PML1.....	104
CMT-02.....	87	J-23CC.....	61	KIT-MM.....	73	PML3.....	104
CMT-03.....	87	J32-CC.....	61	KIT-W1.....	73	PPLLJ.....	97
CMT-04.....	87	J50-CC.....	61	LAV-12.....	60	PPQ.....	97
CMT-05.....	87	JA-BA.....	59	LAV-13.....	60	PR-700.....	56
CNA-01.....	87	JE-02C.....	61	M-23MT.....	42	PR-94C.....	58
CPI-06.....	67	JE-03C.....	61	M-34MC.....	42	PR-96C.....	56
CPI-08.....	67	JE-04C.....	61	M-34MQ.....	42	PRA-BA.....	59
CPI-12.....	67	JE-05C.....	61	M-36P.....	38	PREG1.....	104
CPVC-1.....	84	JE-107.....	55	M-37MM.....	42	PRP.....	55
CPVC-2.....	84	JE-108.....	55	M-84L.....	116	PV-700.....	56
CRP-1.....	83	JE-120.....	62	M-PO.....	40	R-1.....	97
CT-01.....	87	JE-12C.....	62	M6-LC.....	40	R-05.....	98
CT-I.....	87	JE-14C.....	62	M6-LS.....	40	R-118.....	84
E-36PF.....	102	JE-20C.....	62	M7-LC.....	40	R-14.....	102
E322B.....	57	JE-20S.....	62	M7-LS.....	40	R-15.....	100
E322C.....	57	JE-220.....	55	MAC.....	38	R-16.....	98
E322N.....	57	JE-23C.....	62	MACE.....	38	R-17.....	102
E324B.....	57	JE-23S.....	62	MCCE.....	38	R-2.....	101
E324N.....	57	JE-260.....	55	MCCM.....	38	R-20.....	98
E325B.....	57	JE-300.....	59	MCCRC.....	40	R-22.....	96
E325N.....	57	JE-301.....	59	MCE.....	38	R-236.....	84
E328B.....	57	JE-303.....	55	MCES.....	38	R-34MC.....	91
E328C.....	57	JE-304.....	59	MCME.....	38	R-34MQ.....	91
E328N.....	57	JE-305.....	59	MCML.....	40	R-36MM.....	91
E329B.....	58	JE-306.....	55	MCRE.....	38	R-36PF.....	94
E329N.....	58	JE-33C.....	62	MCRG.....	38	R-473.....	84
E360B.....	58	JE-502.....	55	MCSG.....	38	R-47CZ.....	102
E360N.....	58	JE-606.....	55	MDL.....	40	R-5.....	95
EX-16S.....	109	JE-700.....	56	ME-03.....	97	R-60.....	84
EX-AG.....	108	JE-910.....	62	ML-A.....	40	R-7.....	100
EX-CER.....	108	JE-91C.....	62	ML-H.....	40	RB-02.....	102
EX-CP1.....	108	JE-94C.....	63	ML-N.....	40	RB-03.....	98
EX-CR.....	109	JE-95C.....	63	ML-R.....	41	RB-71E.....	91
EX-CR1.....	107	JE32-C.....	63	MLA-C.....	41	RB-72E.....	91
EX-I.....	105	JE32-S.....	63	MLH-C.....	41	RB-73C.....	91
EX-II.....	105	JE50-C.....	63	MLN-C.....	41	RB-73F.....	91
EX-III.....	105	JE90-C.....	63	MMEC.....	42	RB-73L.....	91
EX-M.....	109	JE95-S.....	63	MMPLC.....	42	RB-74C.....	91
EX-M1.....	107	JE96-C.....	63	MNC.....	38	RB-74F.....	91
EX-M2.....	107	JE96-S.....	63	MNCC.....	38	RB-74L.....	91
EX-MA.....	106	JE97-C.....	63	MPC.....	41	RB-79E.....	91
EX-MA1.....	107	JE97-S.....	64	MPL.....	41	RC-01.....	96
EX-MA2.....	105	JE98-C.....	64	MRBC.....	39	RC-03.....	97
EX-RA.....	109	JE99-C.....	64	MRBE.....	39	RC-04.....	97
EXT.....	108	KIT-B4.....	72	MRC.....	39	RC-05.....	97
F-C.....	89	KIT-CA.....	109	MRCC.....	39	RC-06.....	100
FLE-3.....	87	KIT-CP 3/8".....	72	MRL.....	41	RC-07.....	100
FLE-5.....	87	KIT-CP 5/16".....	72	MRNC.....	39	RC-08.....	98
FLE-8.....	87	KIT-F1.....	72	MRNE.....	39	RC-09.....	102
FS-01.....	89	KIT-F2.....	72	MSL.....	41	RC-10.....	98
GA-700.....	56	KIT-F3.....	72	NC.....	118 y 119	RC-11.....	96

ÍNDICE ALFANUMÉRICO

RC-36C.....	92	RI-64.....	102
RCP-01.....	67	RI-67.....	41
RCP-02 1 SELENOIDE.....	67	RI-69.....	95
RCP-02 2 SELENOIDES.....	67	RI-73.....	42
RCP-03.....	67	RI-98.....	94
RCP-04.....	67	RI-81.....	41
RCP-05.....	67	RL-01.....	96
RCP-06.....	67	RL-02.....	42
RCP-07.....	67	RL-06.....	102
RCP-08.....	67	RL-07.....	100
RE-01.....	96	RL-07P.....	100
RE-03.....	96	RL-08.....	99
RE-04.....	39	RL-12.....	42
RE-05.....	39	RL-30.....	42
RE-06.....	39	RL-31.....	42
RE-07.....	43	RM-8ST.....	99
RE-08.....	98	RP-24T.....	95
RE-09.....	99	RR-01.....	13
RE-10.....	97	RR-02.....	99
RE-11.....	97	RR-04.....	102
RE-12.....	39	RT-03.....	101
RE-13.....	39	RT-05.....	102
RE-15.....	43	RT-08.....	99
RE-16.....	97	RTI-21.....	96
RE-17.....	97	RV-01.....	99
RE-18.....	99	SL-1.....	77
RE-20.....	97	SL-F.....	77
RE-30.....	39	STB.....	64
RE-31.....	39	STS.....	64
RF-01.....	13	T-34MC.....	101
RF-02.....	13	TA-700.....	56
RF-03.....	99	TA-94C.....	58
RF-04.....	100	TB-700.....	56
RF-05.....	99	TB-94C.....	58
RF-06.....	13	TB-96C.....	56
RF-07.....	100	TB-ABA.....	59
RFR-01.....	52	TC.....	119
RI-02.....	94	TCR.....	119
RI-14.....	94	TEE-DP.....	119
RI-21.....	102	TEE-DC.....	119
RI-22.....	102	TG-96C.....	56
RI-28.....	102	TM-001.....	60
RI-29.....	102	TPAP.....	111
RI-30.....	102	V-PP.....	82
RI-32.....	39	V-PPRF.....	82
RI-34.....	41		
RI-36C.....	92		
RI-38.....	96		
RI-41.....	92		
RI-46.....	41		
RI-47.....	59		
RI-48.....	60		
RI-49.....	99		
RI-51.....	27		
RI-53.....	39		
RI-55.....	39		
RI-57.....	39		
RI-59.....	39		
RI-61.....	41		
RI-63.....	41		

NOTAS

MONOMANDOS FREGADERO

	<ul style="list-style-type: none">Cuerpo y pico de latón						
FIGURA 004-FM	ACABADO CROMO	CONT. MASTER 10	PRECIO UNITARIO \$3,660.64		<ul style="list-style-type: none">Cuerpo y pico de latón		
				FIGURA 005-FM	ACABADO CROMO	CONT. MASTER 10	PRECIO UNITARIO \$3,502.92
	<ul style="list-style-type: none">Cuerpo y pico de latón				<ul style="list-style-type: none">Cuerpo y chapetón de latónPico retráctil con dos funciones		
FIGURA 006-FM	ACABADO CROMO	CONT. MASTER 12	PRECIO UNITARIO \$3,533.55	FIGURA 008-FM	ACABADO CROMO	CONT. MASTER 6	PRECIO UNITARIO \$5,042.11
	<ul style="list-style-type: none">Cuerpo y pico de latónDos funciones				<ul style="list-style-type: none">Cuerpo y pico de latónManguera de acero inoxidableManeral metálico		
FIGURA 009-FM	ACABADO CROMO	CONT. MASTER 5	PRECIO UNITARIO \$8,932.26	FIGURA 010-FM	ACABADO CROMO	CONT. MASTER 5	PRECIO UNITARIO \$4,782.09
	<ul style="list-style-type: none">Cuerpo y pico de latónCon chapetón				<ul style="list-style-type: none">Cuerpo y pico de latón		
FIGURA 104-FM	ACABADO CROMO	CONT. MASTER 10	PRECIO UNITARIO \$2,240.34	FIGURA 107-FM	ACABADO CROMO	CONT. MASTER 10	PRECIO UNITARIO \$5,266.25
	<ul style="list-style-type: none">Cuerpo de latónPico de latón				<ul style="list-style-type: none">Cuerpo de latónPico de latón		
FIGURA 109-FM	ACABADO CROMO	CONT. MASTER 6	PRECIO UNITARIO \$1,705.35	FIGURA 111-FM	ACABADO CROMO	CONT. MASTER 10	PRECIO UNITARIO \$3,049.78

Estos precios **NO** incluyen I.V.A.-Esta lista sustituye a las anteriores-Sujetos a cambios sin previo aviso.

La información e imágenes contenidas pueden sufrir cambios sin previo aviso, por motivos de actualización y mejora continua sin responsabilidad alguna por la marca o su publicidad

MONOMANDOS FREGADERO



- Cuerpo y pico de latón
- Con chapetón

FIGURA
614-RA

ACABADO
CROMO

CONT. MASTER
8

PRECIO UNITARIO
\$4,587.66



- Cuerpo y pico de latón

FIGURA
7-C

ACABADO
CROMO

CONT. MASTER
10

PRECIO UNITARIO
\$1,648.40



- Cuerpo y pico de latón
- Con chapetón

FIGURA
7-IM

ACABADO
CROMO

CONT. MASTER
10

PRECIO UNITARIO
\$1,895.18



- Cuerpo y pico de latón
- Con chapetón

FIGURA
7-MC

ACABADO
CROMO

CONT. MASTER
12

PRECIO UNITARIO
\$1,439.58



- Cuerpo y pico de latón
- Con chapetón

FIGURA
7-MQ

ACABADO
CROMO

CONT. MASTER
20

PRECIO UNITARIO
\$1,199.28



- Cuerpo y pico de latón
- Con chapetón

FIGURA
7-MS

ACABADO
SATINADO

CONT. MASTER
12

PRECIO UNITARIO
\$1,713.26



- Cuerpo y pico de latón
- Dos funciones
- Con chapetón

FIGURA
8-ST

ACABADO
CROMO

CONT. MASTER
10

PRECIO UNITARIO
\$2,389.54



- Cuerpo y chapetón de latón
- Pico retráctil con dos funciones

**-40%
EXTRA**

FIGURA
8-TC

ACABADO
CROMO

CONT. MASTER
6

PRECIO UNITARIO
\$8,513.97

MEZCLADORAS FREGADERO



- Cuerpo de bronce
- Pico de acero inoxidable
- Chapetón de acero inoxidable

FIGURA
6-LC

ACABADO
CROMO

CONT. MASTER
12

PRECIO UNITARIO
\$1,815.54



- Cuerpo de bronce
- Pico de acero inoxidable
- Chapetón de acero inoxidable

FIGURA
6-LS

ACABADO
SATINADO

CONT. MASTER
12

PRECIO UNITARIO
\$2,007.57



Estos precios **NO** incluyen I.V.A.-Esta lista sustituye a las anteriores-Sujetos a cambios sin previo aviso.
La información e imágenes contenidas pueden sufrir cambios sin previo aviso, por motivos de actualización y mejora continua sin responsabilidad alguna por la marca o su publicidad

MEZCLADORAS FREGADERO



- Cuerpo de latón
- Pico de acero inoxidable
- Chapetón A.B.S.



FIGURA 6-P **ACABADO** CROMO **CONT. MASTER** 20 **PRECIO UNITARIO** \$576.42



- Cuerpo de bronce
- Pico de acero inoxidable
- Chapetón de acero inoxidable



FIGURA 7-LC **ACABADO** CROMO **CONT. MASTER** 12 **PRECIO UNITARIO** \$1,723.90



- Cuerpo de latón
- Pico de acero inoxidable
- Chapetón de acero inoxidable



FIGURA 7-LCC **ACABADO** CROMO **CONT. MASTER** 12 **PRECIO UNITARIO** \$1,436.57



- Cuerpo de latón
- Pico de acero inoxidable
- Chapetón de acero inoxidable



FIGURA 7-LCCS **ACABADO** SATINADO **CONT. MASTER** 12 **PRECIO UNITARIO** \$2,094.51



- Cuerpo de bronce
- Pico de acero inoxidable
- Chapetón de acero inoxidable



FIGURA 7-LS **ACABADO** SATINADO **CONT. MASTER** 12 **PRECIO UNITARIO** \$1,982.11



- Cuerpo de bronce
- Pico de acero inoxidable
- Chapetón de acero inoxidable



FIGURA 8-BM **ACABADO** CROMO **CONT. MASTER** 12 **PRECIO UNITARIO** \$1,294.04



- Cuerpo de latón
- Pico de acero inoxidable
- Chapetón de acero inoxidable



FIGURA 8-BT **ACABADO** CROMO **CONT. MASTER** 10 **PRECIO UNITARIO** \$2,042.49



- Cuerpo de bronce
- Pico de acero inoxidable
- Chapetón de acero inoxidable



FIGURA 8-CR **ACABADO** CROMO **CONT. MASTER** 20 **PRECIO UNITARIO** \$1,072.89



- Cuerpo de bronce
- Pico flexible de acero inoxidable
- Chapetón de acero inoxidable
- Dos funciones



FIGURA 8-CRF **ACABADO** CROMO **CONT. MASTER** 12 **PRECIO UNITARIO** \$1,680.19



- Cuerpo de bronce
- Pico y chapetón de acero inoxidable



FIGURA 8-D **ACABADO** CROMO **CONT. MASTER** 20 **PRECIO UNITARIO** \$1,006.12

Estos precios **NO** incluyen I.V.A.-Esta lista sustituye a las anteriores-Sujetos a cambios sin previo aviso.

La información e imágenes contenidas pueden sufrir cambios sin previo aviso, por motivos de actualización y mejora continua sin responsabilidad alguna por la marca o su publicidad

MEZCLADORAS FREGADERO



- Cuerpo de bronce
- Pico de acero inoxidable
- Chapetón de acero inoxidable



FIGURA 8-G **ACABADO** CROMO **CONT. MASTER** 20 **PRECIO UNITARIO** \$1,055.00



- Cuerpo de bronce
- Pico flexible de acero inoxidable
- Chapetón de acero inoxidable
- Dos funciones



FIGURA 8-GF **ACABADO** CROMO **CONT. MASTER** 12 **PRECIO UNITARIO** \$1,722.75



- Cuerpo de bronce
- Pico de acero inoxidable
- Chapetón de acero inoxidable



FIGURA 8-I **ACABADO** CROMO **CONT. MASTER** 20 **PRECIO UNITARIO** \$862.04



- Cuerpo de bronce
- Pico de acero inoxidable
- Chapetón de acero inoxidable

Cartucho Cerámico



FIGURA 8-IC **ACABADO** CROMO **CONT. MASTER** 20 **PRECIO UNITARIO** \$1,269.28



- Cuerpo de bronce
- Pico de acero inoxidable
- Chapetón de acero inoxidable

Cartucho compresión



FIGURA 8-IC **ACABADO** CROMO **CONT. MASTER** 20 **PRECIO UNITARIO** \$1,269.28



- Cuerpo de bronce
- Pico de acero inoxidable
- Chapetón de acero inoxidable



FIGURA 8-ICC **ACABADO** CROMO **CONT. MASTER** 12 **PRECIO UNITARIO** \$1,534.49



- Cuerpo de bronce
- Pico de acero inoxidable
- Chapetón de acero inoxidable



FIGURA 8-ID **ACABADO** CROMO **CONT. MASTER** 12 **PRECIO UNITARIO** \$1,173.81



- Cuerpo de bronce
- Pico de acero inoxidable
- Chapetón A.B.S.



FIGURA 8-IE **ACABADO** CROMO **CONT. MASTER** 20 **PRECIO UNITARIO** \$718.36



- Cuerpo de bronce
- Pico de acero inoxidable
- Chapetón de acero inoxidable



FIGURA 8-IG **ACABADO** CROMO **CONT. MASTER** 12 **PRECIO UNITARIO** \$988.72



- Cuerpo de bronce
- Pico de acero inoxidable
- Chapetón de acero inoxidable



FIGURA 8-IGN **ACABADO** CROMO **CONT. MASTER** 20 **PRECIO UNITARIO** \$1,135.84

Estos precios **NO** incluyen I.V.A.-Esta lista sustituye a las anteriores-Sujetos a cambios sin previo aviso.

La información e imágenes contenidas pueden sufrir cambios sin previo aviso, por motivos de actualización y mejora continua sin responsabilidad alguna por la marca o su publicidad

MEZCLADORAS FREGADERO



- Cuerpo de bronce
- Pico de acero inoxidable
- Chapetón de acero inoxidable



FIGURA 8-IL **ACABADO CROMO** **CONT. MASTER 20** **PRECIO UNITARIO \$869.44**



- Cuerpo de bronce
- Pico de acero inoxidable
- Chapetón de acero inoxidable



FIGURA 8-IM **ACABADO CROMO** **CONT. MASTER 20** **PRECIO UNITARIO \$1,135.84**



- Cuerpo de bronce
- Pico de acero inoxidable
- Chapetón de acero inoxidable

Cartucho compresión



FIGURA 8-IN **ACABADO CROMO** **CONT. MASTER 20** **PRECIO UNITARIO \$860.58**



- Cuerpo de bronce
- Pico de acero inoxidable
- Chapetón de acero inoxidable 304



FIGURA 8-IP **ACABADO CROMO** **CONT. MASTER 20** **PRECIO UNITARIO \$1,123.19**



- Cuerpo de bronce
- Pico flexible de acero inoxidable
- Chapetón de acero inoxidable
- Dos funciones



FIGURA 8-IPF **ACABADO CROMO** **CONT. MASTER 12** **PRECIO UNITARIO \$1,654.72**



- Cuerpo de latón
- Pico de acero inoxidable
- Chapetón de acero inoxidable



FIGURA 8-IPO **ACABADO CROMO-LATÓN** **CONT. MASTER 12** **PRECIO UNITARIO \$1,884.58**



- Cuerpo de bronce
- Pico de acero inoxidable
- Chapetón de A.B.S.



FIGURA 8-IPP **ACABADO CROMO** **CONT. MASTER 20** **PRECIO UNITARIO \$1,010.87**



- Cuerpo de bronce
- Pico de acero inoxidable
- Chapetón de acero inoxidable



FIGURA 8-IR **ACABADO CROMO** **CONT. MASTER 20** **PRECIO UNITARIO \$914.37**



- Cuerpo de bronce
- Pico de acero inoxidable
- Chapetón de acero inoxidable



FIGURA 8-IS **ACABADO CROMO** **CONT. MASTER 20** **PRECIO UNITARIO \$914.37**



- Cuerpo de latón
- Pico de acero inoxidable
- Chapetón de acero inoxidable



FIGURA 8-LC **ACABADO CROMO** **CONT. MASTER 6** **PRECIO UNITARIO \$1,664.21**
FIGURA 8-LS **ACABADO SATINADA** **CONT. MASTER 6** **PRECIO UNITARIO \$2,012.24**

Estos precios **NO** incluyen I.V.A.-Esta lista sustituye a las anteriores-Sujetos a cambios sin previo aviso.

La información e imágenes contenidas pueden sufrir cambios sin previo aviso, por motivos de actualización y mejora continua sin responsabilidad alguna por la marca o su publicidad

MEZCLADORAS FREGADERO



- Cuerpo de latón
- Pico de acero inoxidable
- Chapetón de acero inoxidable

FIGURA
8-MF

ACABADO
CROMO

CONT. MASTER
10

PRECIO UNITARIO
\$2,116.65



- Cuerpo de bronce
- Pico de acero inoxidable
- Chapetón de acero inoxidable

FIGURA
8-P

ACABADO
CROMO

CONT. MASTER
20

PRECIO UNITARIO
\$953.25





- Cuerpo de bronce
- Pico de acero inoxidable
- Chapetón de acero inoxidable

FIGURA
8-PP

ACABADO
CROMO

CONT. MASTER
20

PRECIO UNITARIO
\$1,006.12





- Cuerpo de bronce
- Pico de acero inoxidable
- Chapetón de acero inoxidable

FIGURA
8-R

ACABADO
CROMO

CONT. MASTER
20

PRECIO UNITARIO
\$895.39





- Cuerpo de bronce
- Pico de acero inoxidable
- Chapetón de acero inoxidable

FIGURA
8-RB

ACABADO
CROMO

CONT. MASTER
10

PRECIO UNITARIO
\$977.65





- Cuerpo de bronce
- Pico de acero inoxidable
- Chapetón de acero inoxidable

FIGURA
8-RBL

ACABADO
CROMO

CONT. MASTER
10

PRECIO UNITARIO
\$1,009.29





- Cuerpo de bronce
- Pico de acero inoxidable
- Chapetón de acero inoxidable

FIGURA
8-RG

ACABADO
CROMO

CONT. MASTER
12

PRECIO UNITARIO
\$1,139.01





- Cuerpo de latón
- Pico de acero inoxidable
- Chapetón de acero inoxidable

FIGURA
8-RP

ACABADO
CROMO

CONT. MASTER
10

PRECIO UNITARIO
\$1,337.54



- Cuerpo de latón
- Pico de acero inoxidable
- Chapetón de acero inoxidable

FIGURA
9-I

ACABADO
CROMO

CONT. MASTER
20

PRECIO UNITARIO
\$1,884.58

- Cuerpo de latón
- Pico de acero inoxidable
- Chapetón de acero inoxidable

FIGURA
9-IC

ACABADO
CROMO

CONT. MASTER
20

PRECIO UNITARIO
\$1,673.71



Estos precios **NO** incluyen I.V.A.-Esta lista sustituye a las anteriores-Sujetos a cambios sin previo aviso.

La información e imágenes contenidas pueden sufrir cambios sin previo aviso, por motivos de actualización y mejora continua sin responsabilidad alguna por la marca o su publicidad

LLAVE INDIVIDUAL FREGADERO



- Cuerpo de bronce
- Pico de acero inoxidable

FIGURA
7-F

ACABADO
CROMO

CONT. MASTER
20

PRECIO UNITARIO
\$680.79



- Cuerpo de bronce
- Pico de acero inoxidable

FIGURA
7-FC

ACABADO
CROMO

CONT. MASTER
20

PRECIO UNITARIO
\$752.76



- Cuerpo de bronce
- Pico de acero inoxidable

FIGURA
7-FL

ACABADO
CROMO

CONT. MASTER
20

PRECIO UNITARIO
\$723.55



- Cuerpo de latón
- Pico de acero inoxidable

FIGURA
7-FPC

ACABADO
CROMO

CONT. MASTER
20

PRECIO UNITARIO
\$777.15



- Cuerpo de latón
- Pico de acero inoxidable

FIGURA
7-FPL

ACABADO
CROMO

CONT. MASTER
20

PRECIO UNITARIO
\$815.43



- Cuerpo de latón
- Pico de acero inoxidable

FIGURA
7-FPT

ACABADO
CROMO

CONT. MASTER
20

PRECIO UNITARIO
\$815.43



LLAVE NIPPLE



- Cuerpo de latón
- Chapetón de acero inoxidable
- Conexión macho
- Medida 13 mm

FIGURA
5-C

ACABADO
CROMO

CONT. MASTER
50

PRECIO UNITARIO
\$333.63



Estos precios **NO** incluyen I.V.A.-Esta lista sustituye a las anteriores-Sujetos a cambios sin previo aviso.
La información e imágenes contenidas pueden sufrir cambios sin previo aviso, por motivos de actualización y mejora continua sin responsabilidad alguna por la marca o su publicidad

CONTROL PARA FILTRO



- Cuerpo de latón
- Conexión Hembra-Macho
- Medida 13 mm x 22 mm



FIGURA 66 **ACABADO CROMO** **CONT. MASTER 50** **PRECIO UNITARIO \$305.10**



- Cuerpo de latón
- Conexión Hembra-Macho
- Medida 13 mm x 13 mm



FIGURA 66-C **ACABADO CROMO** **CONT. MASTER 120** **PRECIO UNITARIO \$297.41**



TARJAS



- De empotrar
- Profundidad 15 cm
- Material de acero inoxidable
- Medida y profundidad 83x56x15

FIGURA 9-DT **ACABADO SATINADO** **CONT. MASTER 5** **PRECIO UNITARIO \$2,091.97**



- De empotrar
- Profundidad 15 cm
- Material de acero inoxidable
- Medida y profundidad 83x56x15

FIGURA 9-ED **ACABADO SATINADO** **CONT. MASTER 5** **PRECIO UNITARIO \$1,788.40**



- De empotrar
- Profundidad 15 cm
- Material de acero inoxidable
- Medida y profundidad 80x52x15

FIGURA 9-EDC **ACABADO SATINADO** **CONT. MASTER 5** **PRECIO UNITARIO \$1,909.38**



- De sobreponer
- Profundidad 15 cm
- Material de acero inoxidable
- Con respaldo y faldón
- Medida y profundidad 75x48x15

FIGURA 9-EDR **ACABADO SATINADO** **CONT. MASTER 5** **PRECIO UNITARIO \$1,322.51**



- De empotrar
- Profundidad 15 cm
- Material de acero inoxidable
- Medida y profundidad 84x56x15

FIGURA 9-EI **ACABADO SATINADO** **CONT. MASTER 5** **PRECIO UNITARIO \$1,788.40**



- De empotrar
- Profundidad 15 cm
- Material de acero inoxidable
- Medida y profundidad 80x52x15

FIGURA 9-EIC **ACABADO SATINADO** **CONT. MASTER 5** **PRECIO UNITARIO \$1,909.38**

Estos precios **NO** incluyen I.V.A.-Esta lista sustituye a las anteriores-Sujetos a cambios sin previo aviso.

La información e imágenes contenidas pueden sufrir cambios sin previo aviso, por motivos de actualización y mejora continua sin responsabilidad alguna por la marca o su publicidad



- De sobreponer
- Profundidad 15 cm
- Material de acero inoxidable
- Con respaldo y faldón
- Medida y profundidad 75x48x15



- De empotrar
- Profundidad 15 cm
- Material de acero inoxidable
- Medida y profundidad 63x56x15

FIGURA	ACABADO	CONT. MASTER	PRECIO UNITARIO	FIGURA	ACABADO	CONT. MASTER	PRECIO UNITARIO
9-EIR	SATINADO	5	\$1,322.51	9-TS	SATINADO	5	\$1,702.18



- De empotrar
- Profundidad 15 cm
- Material de acero inoxidable
- Medida y profundidad 48x48x15



- De empotrar
- Profundidad 15 cm
- Material de acero inoxidable
- Medida y profundidad 100x50x15

FIGURA	ACABADO	CONT. MASTER	PRECIO UNITARIO	FIGURA	ACABADO	CONT. MASTER	PRECIO UNITARIO
9-TSE	SATINADO	5	\$1,374.75	10-ED	SATINADO	5	\$1,927.56



- De empotrar
- Profundidad 15 cm
- Material de acero inoxidable
- Medida y profundidad 100x50x15



- De sobreponer
- Profundidad 15 cm
- Material de acero inoxidable
- Con respaldo y faldón
- Medida y profundidad 80x50x13

FIGURA	ACABADO	CONT. MASTER	PRECIO UNITARIO	FIGURA	ACABADO	CONT. MASTER	PRECIO UNITARIO
10-EI	SATINADO	5	\$1,927.56	10-EIR	SATINADO	5	\$1,895.18



- De empotrar
- Profundidad 15 cm
- Material de acero inoxidable
- Medida y profundidad 38x38x15

FIGURA	ACABADO	CONT. MASTER	PRECIO UNITARIO
10-TB	SATINADO	5	\$1,157.99



Estos precios **NO** incluyen I.V.A.-Esta lista sustituye a las anteriores-Sujetos a cambios sin previo aviso.
La información e imágenes contenidas pueden sufrir cambios sin previo aviso, por motivos de actualización y mejora continua sin responsabilidad alguna por la marca o su publicidad

MEDIA TRAMPA



- Material de latón
- Diámetro 1 1/2"
- Con registro

FIGURA 10-B ACABADO CROMO CONT. MASTER 30 PRECIO UNITARIO \$740.35

MEDIA TRAMPA



- Material de P.V.C.
- Diámetro 1 1/2"
- Flexible y con registro

FIGURA 10-LF CONT. MASTER 60 PRECIO UNITARIO \$98.08



MEDIA TRAMPA



- Material de latón
- Diámetro 1 1/2"

FIGURA 11-B ACABADO CROMO CONT. MASTER 20 PRECIO UNITARIO \$582.16

MEDIA TRAMPA



- Material de acero inoxidable
- Diámetro 1 1/2"

FIGURA 11-BA ACABADO CROMO CONT. MASTER 50 PRECIO UNITARIO \$507.97

MEDIA TRAMPA



- Material de polipropileno
- Diámetro 1 1/2"
- Flexible

FIGURA 11-PTF CONT. MASTER 70 PRECIO UNITARIO \$80.84



MEDIA TRAMPA



- Material de P.V.C.
- Diámetro 1 1/2"
- Con registro

FIGURA 11-R CONT. MASTER 60 PRECIO UNITARIO \$66.44



MEDIA TRAMPA



- Material de polipropileno
- Diámetro 1 1/2"
- Con registro y salida flexible

FIGURA 11-RF CONT. MASTER 50 PRECIO UNITARIO \$120.23



MEDIA TRAMPA



- Material de P.V.C.
- Diámetro 1 1/2"
- Con registro

FIGURA 11-RS CONT. MASTER 60 PRECIO UNITARIO \$83.84



TRAMPA COMPLETA



- Material de polipropileno
- Diámetro 1 1/2"
- Flexible y con contra canasta

FIGURA 10-PPF CONT. MASTER 30 PRECIO UNITARIO \$252.16

Estos precios **NO** incluyen I.V.A.-Esta lista sustituye a las anteriores-Sujetos a cambios sin previo aviso.

La información e imágenes contenidas pueden sufrir cambios sin previo aviso, por motivos de actualización y mejora continua sin responsabilidad alguna por la marca o su publicidad

TRAMPA COMPLETA

- Material de polipropileno
- Diámetro 1 1/2"
- Flexible



FIGURA 10-PTF **CONT. MASTER 50** **PRECIO UNITARIO \$108.93**

HECHO EN MÉXICO

TRAMPA COMPLETA

- Material de polipropileno
- Diámetro 1 1/2"
- Con registro



FIGURA 10-R **CONT. MASTER 40** **PRECIO UNITARIO \$98.56**

HECHO EN MÉXICO

TRAMPA COMPLETA

- Material de polipropileno
- Diámetro 1 1/2"
- Con registro



FIGURA 10-RF **CONT. MASTER 40** **PRECIO UNITARIO \$135.32**

HECHO EN MÉXICO

TRAMPA COMPLETA

- Material de P.V.C.
- Diámetro 1 1/2"
- Con registro



FIGURA 11-P **CONT. MASTER 40** **PRECIO UNITARIO \$115.36**

HECHO EN MÉXICO

TRAMPA COMPLETA

- Material de P.V.C.
- Diámetro 1 1/2"
- Con registro



FIGURA 11-PF **CONT. MASTER 45** **PRECIO UNITARIO \$120.23**

HECHO EN MÉXICO

MEDIA TRAMPA

- Material de polipropileno
- Diámetro 1 1/2"
- Flexible



FIGURA 11-PT **CONT. MASTER 100** **PRECIO UNITARIO \$51.70**

SALIDA CENTRAL FREGADERO

- Material de latón
- Diámetro 1 1/2"
- Para doble tina



FIGURA 11-E **ACABADO CROMO** **CONT. MASTER 20** **PRECIO UNITARIO \$1,094.71**

SALIDA CENTRAL FREGADERO

- Material de polipropileno
- Diámetro 1 1/2"
- Para doble tina



FIGURA 11-EP **CONT. MASTER 20** **PRECIO UNITARIO \$121.18**

HECHO EN MÉXICO

SALIDA CENTRAL FREGADERO

- Material de polipropileno
- Diámetro 1 1/2"
- Para doble tina
- Salida flexible



FIGURA 11-EPF **CONT. MASTER 15** **PRECIO UNITARIO \$211.86**

Estos precios **NO** incluyen I.V.A.-Esta lista sustituye a las anteriores-Sujetos a cambios sin previo aviso.
La información e imágenes contenidas pueden sufrir cambios sin previo aviso, por motivos de actualización y mejora continua sin responsabilidad alguna por la marca o su publicidad

CONTRAS FREGADERO



- Rejilla de acero inoxidable
- Diámetro de 2"
- Tubo de acero inoxidable

FIGURA
12-IL

CONT. MASTER
50

PRECIO UNITARIO
\$237.36



- Con cubierta de acero inoxidable
- Diámetro de 2"
- Contra rejilla de polipropileno

FIGURA
12-PA

CONT. MASTER
100

PRECIO UNITARIO
\$100.72



- Diámetro de 2"
- Contra rejilla de polipropileno

FIGURA
12-PR

CONT. MASTER
100

PRECIO UNITARIO
\$45.09



- Contra canasta de acero inoxidable
- Diámetro de 4"
- Tubo de latón
- Fácil instalación

FIGURA
13-AC

CONT. MASTER
50

PRECIO UNITARIO
\$427.13



- Contra canasta de acero inoxidable
- Diámetro de 4"
- Sin tubo

FIGURA
13-I

CONT. MASTER
50

PRECIO UNITARIO
\$196.40



- Contra canasta de acero inoxidable
- Diámetro de 4"
- Tubo de acero inoxidable

FIGURA
13-IL

CONT. MASTER
50

PRECIO UNITARIO
\$219.58



- Contra canasta de acero inoxidable
- Diámetro de 4"
- Tubo de polipropileno

FIGURA
13-IP

CONT. MASTER
50

PRECIO UNITARIO
\$183.20



- Contra canasta de A.B.S
- Diámetro de 4"
- Tubo de polipropileno
- Ceja de acero inoxidable

FIGURA
13-PP

CONT. MASTER
50

PRECIO UNITARIO
\$100.61



- Material polipropileno
- Diámetro de 4"

FIGURA
13-R

CONT. MASTER
100

PRECIO UNITARIO
\$65.56

Estos precios **NO** incluyen I.V.A.-Esta lista sustituye a las anteriores-Sujetos a cambios sin previo aviso.

La información e imágenes contenidas pueden sufrir cambios sin previo aviso, por motivos de actualización y mejora continua sin responsabilidad alguna por la marca o su publicidad



TUBO CON PESTAÑA

- Para contra canasta
- Diámetro 1 1/2" (38mm)
- Largo 4" (10cm)



FIGURA	MEDIDA	CONT. MASTER	PRECIO UNITARIO
11-TR	38 mm Ø x 10 cm	300	\$15.66



CONECTOR PARA CESPOL

- Para fregadero
- Material de vinilo
- Medida de 2" x 1 1/2"



FIGURA	CONT. MASTER	PRECIO UNITARIO
11-U	10000	\$14.40



EXTENSIÓN PARA FREGADERO

- Material de latón
- Diámetro 1 1/2" (38mm)
- Largo 6" (15cm)



FIGURA	MEDIDA	CONT. MASTER	PRECIO UNITARIO
14	38 mm Ø x 15 cm	50	\$193.00



EXTENSIÓN PARA FREGADERO

- Material de polipropileno
- Diámetro 1 1/2" (38mm)
- Largo 8" (20cm)



FIGURA	MEDIDA	CONT. MASTER	PRECIO UNITARIO
14-PR	Ø 38 mm x 20 cm	200	\$27.78



CANASTILLA MALLA P/FREGADERO (CEDAZO)

- Para contra canasta
- Material de acero inoxidable
- Diámetro de 4"

FIGURA	CONT. MASTER	PRECIO UNITARIO
CA-01	300	\$72.33



CANASTILLA P/ FREGADERO

- Para contra canasta 13-IL
- Material de acero inoxidable

FIGURA	CONT. MASTER	PRECIO UNITARIO
RF-01	100	\$67.07



REJILLA

- Para fig. 12-IL
- Material de acero inoxidable

FIGURA	CONT. MASTER	PRECIO UNITARIO
RF-02	200	\$104.41



TUBO CON PESTAÑA

- Para contra canasta
- Material de latón
- Para fig. 12-IL y 13-IL



FIGURA	MEDIDA	CONT. MASTER	PRECIO UNITARIO
RF-06	38 mm Ø x 10 cm	100	\$110.74
	38 mm Ø x 15 cm	100	\$147.28
	38 mm Ø x 20 cm	100	\$186.67

REJILLA

- Para fig. 12-A
- Material de acero inoxidable



FIGURA	CONT. MASTER	PRECIO UNITARIO
RR-01	X	\$30.22

Estos precios **NO** incluyen I.V.A.-Esta lista sustituye a las anteriores-Sujetos a cambios sin previo aviso.

La información e imágenes contenidas pueden sufrir cambios sin previo aviso, por motivos de actualización y mejora continua sin responsabilidad alguna por la marca o su publicidad

MONOMANDOS LAVABO



- Cuerpo y chapetón de latón
- Con desagüe automático



FIGURA 20-MC **ACABADO** CROMO **CONT. MASTER** 10 **PRECIO UNITARIO** \$2,388.75



- Cuerpo de latón



FIGURA 23-MCC **ACABADO** CROMO **CONT. MASTER** 16 **PRECIO UNITARIO** \$3,401.20



- Cuerpo y chapetón de acero inoxidable



FIGURA 23-MM **ACABADO** CROMO **CONT. MASTER** 20 **PRECIO UNITARIO** \$1,636.61



- Cuerpo de latón
- Chapetón de acero inoxidable



FIGURA 23-MQ **ACABADO** CROMO **CONT. MASTER** 20 **PRECIO UNITARIO** \$1,515.51



- Cuerpo y chapetón de acero inoxidable



FIGURA 23-MTC **ACABADO** CROMO **CONT. MASTER** 20 **PRECIO UNITARIO** \$1,471.22



- Cuerpo de acero inoxidable



FIGURA 23-MTL **ACABADO** CROMO **CONT. MASTER** 20 **PRECIO UNITARIO** \$1,629.41



- Cuerpo de acero inoxidable



FIGURA 23-MTS **ACABADO** CROMO **CONT. MASTER** 20 **PRECIO UNITARIO** \$1,247.37



- Cuerpo de acero inoxidable



FIGURA 23-TLS **ACABADO** SATINADO **CONT. MASTER** 20 **PRECIO UNITARIO** \$1,740.82



- Cuerpo de latón
- Chapetón acero inoxidable



FIGURA 24-MC **ACABADO** CROMO **CONT. MASTER** 12 **PRECIO UNITARIO** \$1,487.83



- Cuerpo de latón



FIGURA 24-MCC **ACABADO** CROMO **CONT. MASTER** 12 **PRECIO UNITARIO** \$1,357.32

Estos precios **NO** incluyen I.V.A.-Esta lista sustituye a las anteriores-Sujetos a cambios sin previo aviso.

La información e imágenes contenidas pueden sufrir cambios sin previo aviso, por motivos de actualización y mejora continua sin responsabilidad alguna por la marca o su publicidad

MONOMANDOS LAVABO



- Cuerpo de latón



FIGURA 24-MCS **ACABADO** CROMO **CONT. MASTER** 12 **PRECIO UNITARIO** \$1,464.89



- Cuerpo de latón



FIGURA 24-MP **ACABADO** CROMO **CONT. MASTER** 12 **PRECIO UNITARIO** \$2,051.22



- Cuerpo de latón
- Chapetón de acero inoxidable



FIGURA 24-MS **ACABADO** SATINADO **CONT. MASTER** 12 **PRECIO UNITARIO** \$1,892.02



- Cuerpo de acero inoxidable
- Chapetón de acero inoxidable

FIGURA 24-MTA **ACABADO** SATINADO **CONT. MASTER** 20 **PRECIO UNITARIO** \$1,388.64



- Cuerpo de acero inoxidable
- Chapetón de acero inoxidable



FIGURA 24-MTC **ACABADO** CROMO **CONT. MASTER** 12 **PRECIO UNITARIO** \$1,345.65



- Cuerpo de acero inoxidable

FIGURA 24-MTL **ACABADO** CROMO **CONT. MASTER** 20 **PRECIO UNITARIO** \$1,566.13



- Cuerpo de acero inoxidable



FIGURA 24-MTS **ACABADO** CROMO **CONT. MASTER** 12 **PRECIO UNITARIO** \$1,218.10



- Cuerpo de latón
- Chapetón de acero inoxidable

FIGURA 103-LM **ACABADO** CROMO **CONT. MASTER** 12 **PRECIO UNITARIO** \$3,007.72



- Cuerpo de latón
- Chapetón de acero inoxidable



FIGURA 105-LM **ACABADO** CROMO **CONT. MTR** 10 **PRECIO UNIT.** \$3,437.84



- Cuerpo de latón

FIGURA 106-LM **ACABADO** CROMO **CONT. MTR** 12 **PRECIO UNIT.** \$2,943.98



- Cuerpo de latón
- Con chapetón

**-40%
EXTRA**

FIGURA 502-RH **ACABADO** CROMO **CONT. MTR** 8 **PRECIO UNIT.** \$4,479.14

Estos precios **NO** incluyen I.V.A.-Esta lista sustituye a las anteriores-Sujetos a cambios sin previo aviso.

La información e imágenes contenidas pueden sufrir cambios sin previo aviso, por motivos de actualización y mejora continua sin responsabilidad alguna por la marca o su publicidad

MEZCLADORAS

LAVABO 4" CIERRE COMPRESIÓN



- Maneral acrílico
- Cuerpo de bronce
- Chapetón de acero inoxidable



FIGURA ACABADO CONT. MTR PRECIO UNIT.
23-IL CROMO 20 \$1,063.07



- Cuerpo de bronce
- Pico y chapetón de acero inoxidable
- Maneral acrílico



FIGURA ACABADO CONT. MTR PRECIO UNIT.
24-CL CROMO 20 \$746.68



- Cuerpo de bronce
- Pico y chapetón de acero inoxidable
- Maneral tauro



FIGURA ACABADO CONT. MTR PRECIO UNIT.
24-CT CROMO 20 \$686.57



- Cuerpo de bronce
- Chapetón de acero inoxidable
- Maneral acuario



FIGURA ACABADO CONT. MASTER PRECIO UNITARIO
24-I CROMO 20 \$1,129.51



- Cuerpo de bronce
- Chapetón de acero inoxidable
- Maneral acrílico



FIGURA ACABADO CONT. MASTER PRECIO UNITARIO
24-IL CROMO 20 \$1,129.51



- Cuerpo de bronce
- Chapetón de acero inoxidable
- Maneral acuario



FIGURA ACABADO CONT. MASTER PRECIO UNITARIO
24-K CROMO 20 \$1,032.88



- Cuerpo de bronce
- Chapetón de acero inoxidable
- Maneral acrílico



FIGURA ACABADO CONT. MASTER PRECIO UNITARIO
24-KL CROMO 20 \$1,098.73



- Cuerpo de latón
- Chapetón de acero inoxidable
- Maneral tauro



FIGURA ACABADO CONT. MASTER PRECIO UNITARIO
24-Q CROMO 20 \$816.29



- Cuerpo de latón
- Chapetón de acero inoxidable
- Maneral acrílico



FIGURA ACABADO CONT. MASTER PRECIO UNITARIO
24-QL CROMO 20 \$841.60



- Cuerpo de bronce
- Chapetón de acero inoxidable
- Maneral rhin



FIGURA ACABADO CONT. MTR PRECIO UNIT.
24-QR CROMO 20 \$923.86



- Cuerpo de bronce
- Chapetón de acero inoxidable
- Maneral sena



FIGURA ACABADO CONT. MTR PRECIO UNIT.
24-QS CROMO 20 \$923.86



- Cuerpo de bronce
- Pico y chapetón de acero inoxidable
- Maneral cruceta



























FIGURA ACABADO CONT. MTR PRECIO UNIT.
24-TH CROMO 20 \$892.22

Estos precios **NO** incluyen I.V.A.-Esta lista sustituye a las anteriores-Sujetos a cambios sin previo aviso.

La información e imágenes contenidas pueden sufrir cambios sin previo aviso, por motivos de actualización y mejora continua sin responsabilidad alguna por la marca o su publicidad











MEZCLADORAS LAVABO 4" CIERRE 90°

 <ul style="list-style-type: none"> • Maneral asia • Pico y chapetón de latón <p>-40% EXTRA</p> 	 <ul style="list-style-type: none"> • Maneral palanca • Con desagüe automático • Cuerpo y chapetón de latón <p>-40% EXTRA</p> 
<p>FIGURA 20-A ACABADO LATÓN-CROMO CONT. MASTER 12 PRECIO UNITARIO \$2,943.98</p>	<p>FIGURA 20-C ACABADO CROMO CONT. MASTER 6 PRECIO UNITARIO \$3,103.36</p>
 <ul style="list-style-type: none"> • Maneral pirulí 	 <ul style="list-style-type: none"> • Maneral palanca  
<p>FIGURA 20-LP ACABADO LATÓN-CROMO CONT. MASTER 20 PRECIO UNITARIO \$1,426.51</p>	<p>FIGURA 20-P ACABADO CROMO CONT. MASTER 20 PRECIO UNITARIO \$1,385.79</p>
 <ul style="list-style-type: none"> • Maneral rumania • Cuerpo y chapetón de latón <p>-40% EXTRA</p> 	 <ul style="list-style-type: none"> • Maneral cruceta • Cuerpo de bronce • Chapetón de acero inoxidable   
<p>FIGURA 20-R ACABADO LATÓN-CROMO CONT. MASTER 12 PRECIO UNITARIO \$3,060.41</p>	<p>FIGURA 20-RCC ACABADO CROMO CONT. MASTER 20 PRECIO UNITARIO \$1,919.06</p>
 <ul style="list-style-type: none"> • Maneral palanca • Cuerpo de latón 	 <ul style="list-style-type: none"> • Maneral rumania • Cuerpo y chapetón de latón <p>-40% EXTRA</p>  
<p>FIGURA 20-RPC ACABADO CROMO CONT. MASTER 12 PRECIO UNITARIO \$2,307.47</p>	<p>FIGURA 20-RVC ACABADO CROMO CONT. MASTER 20 PRECIO UNITARIO \$2,323.80</p>
 <ul style="list-style-type: none"> • Maneral regio • De A.B.S. 	 <ul style="list-style-type: none"> • Maneral cruceta • Cuerpo de bronce • Pico de acero inoxidable • Chapetón de A.B.S.  
<p>FIGURA 21-P ACABADO CROMO CONT. MASTER 20 PRECIO UNITARIO \$427.19</p>	<p>FIGURA 21-PH ACABADO CROMO CONT. MASTER 20 PRECIO UNITARIO \$723.55</p>

Estos precios **NO** incluyen I.V.A.-Esta lista sustituye a las anteriores-Sujetos a cambios sin previo aviso.

La información e imágenes contenidas pueden sufrir cambios sin previo aviso, por motivos de actualización y mejora continua sin responsabilidad alguna por la marca o su publicidad





















MEZCLADORAS LAVABO 4" CIERRE 90°

	<ul style="list-style-type: none"> • Maneral acrílico • Cuerpo de latón 		<ul style="list-style-type: none"> • Maneral cruceta • Cuerpo de bronce • Chapetón de acero inoxidable
FIGURA 22-CL	ACABADO CROMO	CONT. MASTER 20	PRECIO UNITARIO \$1,519.85
	<ul style="list-style-type: none"> • Maneral minimalista • Cuerpo de bronce • Chapetón de acero inoxidable 		<ul style="list-style-type: none"> • Maneral acuario • Cuerpo de bronce • Chapetón de acero inoxidable
FIGURA 23-CRM	ACABADO CROMO	CONT. MASTER 20	PRECIO UNITARIO \$1,151.66
	<ul style="list-style-type: none"> • Maneral pirulí • Cuerpo de bronce • Chapetón de acero inoxidable 		<ul style="list-style-type: none"> • Maneral acuario • Cuerpo de bronce • Chapetón de A.B.S.
FIGURA 23-IB	ACABADO CROMO	CONT. MASTER 20	PRECIO UNITARIO \$1,255.69
	<ul style="list-style-type: none"> • Maneral acrílico • Cuerpo de bronce • Chapetón de acero inoxidable 		<ul style="list-style-type: none"> • Maneral acuario • Cuerpo de bronce • Chapetón de acero inoxidable
FIGURA 23-IL	ACABADO CROMO	CONT. MASTER 20	PRECIO UNITARIO \$1,075.73
	<ul style="list-style-type: none"> • Maneral rhin • Cuerpo de bronce • Chapetón de acero inoxidable 		<ul style="list-style-type: none"> • Maneral sena • Cuerpo de bronce • Chapetón de acero inoxidable
FIGURA 23-IRR	ACABADO CROMO	CONT. MASTER 20	PRECIO UNITARIO \$1,051.07

Estos precios **NO** incluyen I.V.A.-Esta lista sustituye a las anteriores-Sujetos a cambios sin previo aviso.

La información e imágenes contenidas pueden sufrir cambios sin previo aviso, por motivos de actualización y mejora continua sin responsabilidad alguna por la marca o su publicidad

MEZCLADORAS LAVABO 4" CIERRE 90°

	<ul style="list-style-type: none"> • Maneral rumania • Cuerpo y chapetón de latón • Con desagüe automático 		<ul style="list-style-type: none"> • Maneral pirulí • Cuerpo de bronce • Chapetón de acero inoxidable
FIGURA 23-MRC	ACABADO CROMO	CONT. MASTER 20	PRECIO UNITARIO \$4,544.00
	<ul style="list-style-type: none"> • Maneral palanca • Cuerpo de latón 		<ul style="list-style-type: none"> • Maneral pirulí • Cuerpo de bronce • Chapetón de acero inoxidable
FIGURA 23-PB	ACABADO CROMO	CONT. MASTER 20	PRECIO UNITARIO \$882.73
	<ul style="list-style-type: none"> • Maneral palanca • Cuerpo de latón 		<ul style="list-style-type: none"> • Maneral pirulí • Cuerpo de bronce • Chapetón de acero inoxidable
FIGURA 23-PH	ACABADO LATÓN	CONT. MASTER 20	PRECIO UNITARIO \$2,148.29
	<ul style="list-style-type: none"> • Maneral esfera • Cuerpo y chapetón de latón 		<ul style="list-style-type: none"> • Maneral palanca • Cuerpo de bronce • Chapetón de acero inoxidable
FIGURA 23-PR	ACABADO CROMO	CONT. MASTER 20	PRECIO UNITARIO \$1,227.60
	<ul style="list-style-type: none"> • Maneral esfera • Cuerpo y chapetón de latón 		<ul style="list-style-type: none"> • Maneral palanca • Cuerpo de bronce • Chapetón de acero inoxidable
FIGURA 23-RC	ACABADO CROMO	CONT. MASTER 10	PRECIO UNITARIO \$1,632.10
	<ul style="list-style-type: none"> • Maneral palanca • Cuerpo de latón 		<ul style="list-style-type: none"> • Maneral palanca • Cuerpo de bronce • Chapetón de acero inoxidable
FIGURA 23-RD	ACABADO CROMO	CONT. MASTER 20	PRECIO UNITARIO \$1,267.18
	<ul style="list-style-type: none"> • Maneral géminis • Cuerpo de bronce • Chapetón de acero inoxidable 		<ul style="list-style-type: none"> • Maneral palanca • Cuerpo de bronce • Chapetón de acero inoxidable
FIGURA 23-RDG	ACABADO CROMO	CONT. MASTER 20	PRECIO UNITARIO \$1,211.78
	<ul style="list-style-type: none"> • Maneral palanca • Cuerpo de latón 		<ul style="list-style-type: none"> • Maneral palanca • Cuerpo de bronce • Chapetón de acero inoxidable
FIGURA 23-RI	ACABADO CROMO	CONT. MASTER 20	PRECIO UNITARIO \$1,069.40
	<ul style="list-style-type: none"> • Maneral palanca • Cuerpo de latón 		<ul style="list-style-type: none"> • Maneral palanca • Cuerpo de latón
FIGURA 23-TM	ACABADO CROMO	CONT. MASTER 16	PRECIO UNITARIO \$1,688.29
	<ul style="list-style-type: none"> • Maneral palanca • Cuerpo de latón 		<ul style="list-style-type: none"> • Maneral palanca • Cuerpo de latón
FIGURA 23-TMO	ACABADO CROMO-LATÓN	CONT. MASTER 16	PRECIO UNITARIO \$1,761.03

Estos precios **NO** incluyen I.V.A.-Esta lista sustituye a las anteriores-Sujetos a cambios sin previo aviso.

La información e imágenes contenidas pueden sufrir cambios sin previo aviso, por motivos de actualización y mejora continua sin responsabilidad alguna por la marca o su publicidad

MEZCLADORAS LAVABO 4" CIERRE 90°



- Maneral palanca
- Cuerpo de latón



- Maneral palermo
- Cuerpo de bronce
- Chapetón de acero inoxidable



FIGURA 23-TMS	ACABADO SATINADO	CONT. MASTER 12	PRECIO UNITARIO \$2,327.62	FIGURA 24-CP	ACABADO CROMO	CONT. MASTER 20	PRECIO UNITARIO \$734.03
-------------------------	----------------------------	---------------------------	--------------------------------------	------------------------	-------------------------	---------------------------	------------------------------------



- Maneral verona
- Cuerpo de bronce
- Chapetón de acero inoxidable



- Maneral acuario
- Cuerpo de bronce
- Chapetón de acero inoxidable



FIGURA 24-CV	ACABADO CROMO	CONT. MASTER 20	PRECIO UNITARIO \$715.04	FIGURA 24-I	ACABADO CROMO	CONT. MASTER 20	PRECIO UNITARIO \$1,129.51
------------------------	-------------------------	---------------------------	------------------------------------	-----------------------	-------------------------	---------------------------	--------------------------------------



- Maneral acrílico
- Cuerpo de bronce
- Chapetón de acero inoxidable



- Maneral minimalista
- Cuerpo de bronce
- Chapetón de acero inoxidable



FIGURA 24-IL	ACABADO CROMO	CONT. MASTER 20	PRECIO UNITARIO \$1,104.20	FIGURA 24-IMM	ACABADO CROMO	CONT. MASTER 20	PRECIO UNITARIO \$1,338.33
------------------------	-------------------------	---------------------------	--------------------------------------	-------------------------	-------------------------	---------------------------	--------------------------------------



- Maneral minimalista
- Cuerpo de bronce
- Pico de acero inoxidable
- Chapetón de acero inoxidable



- Maneral pirulí
- Cuerpo de bronce
- Pico de acero inoxidable
- Chapetón de acero inoxidable



FIGURA 24-MR	ACABADO CROMO	CONT. MASTER 20	PRECIO UNITARIO \$694.48	FIGURA 24-P	ACABADO CROMO	CONT. MASTER 20	PRECIO UNITARIO \$1,405.00
------------------------	-------------------------	---------------------------	------------------------------------	-----------------------	-------------------------	---------------------------	--------------------------------------



- Maneral pirulí
- Cuerpo de bronce
- Pico de acero inoxidable
- Chapetón de acero inoxidable



- Maneral niza
- Cuerpo de bronce
- Pico de acero inoxidable
- Chapetón de acero inoxidable



FIGURA 24-PB	ACABADO CROMO	CONT. MASTER 20	PRECIO UNITARIO \$787.81	FIGURA 24-PP	ACABADO CROMO	CONT. MASTER 20	PRECIO UNITARIO \$768.83
------------------------	-------------------------	---------------------------	------------------------------------	------------------------	-------------------------	---------------------------	------------------------------------

DISPONIBLE EN JUNIO 2022

Estos precios **NO** incluyen I.V.A.-Esta lista sustituye a las anteriores-Sujetos a cambios sin previo aviso.
La información e imágenes contenidas pueden sufrir cambios sin previo aviso, por motivos de actualización y mejora continua sin responsabilidad alguna por la marca o su publicidad

MEZCLADORAS LAVABO 4" CIERRE 90°



- Maneral palanca
- Cuerpo de bronce
- Chapetón de acero inoxidable



FIGURA 24-R **ACABADO** CROMO **CONT. MASTER** 20 **PRECIO UNITARIO** \$1,064.02



- Maneral cruceta
- Cuerpo de bronce
- Chapetón de acero inoxidable



FIGURA 24-RM **ACABADO** CROMO **CONT. MASTER** 20 **PRECIO UNITARIO** \$1,468.05



- Maneral minimalista
- Cuerpo de bronce
- Chapetón de acero inoxidable



FIGURA 24-RMM **ACABADO** CROMO **CONT. MASTER** 20 **PRECIO UNITARIO** \$1,449.07



- Maneral géminis
- Cuerpo de latón
- Pico flexible
- Cubierta de acero inoxidable



FIGURA 24-SP **ACABADO** CROMO **CONT. MASTER** 20 **PRECIO UNITARIO** \$1,259.39



- Maneral acuario
- Cuerpo de latón
- Pico de acero inoxidable
- Chapetón de acero inoxidable



FIGURA 24-T **ACABADO** CROMO **CONT. MASTER** 20 **PRECIO UNITARIO** \$673.91



- Maneral palanca
- Cuerpo de bronce
- Pico de acero inoxidable
- Chapetón de acero inoxidable



FIGURA 24-TD **ACABADO** CROMO **CONT. MASTER** 20 **PRECIO UNITARIO** \$787.81



- Maneral géminis
- Cuerpo de bronce
- Pico de acero inoxidable
- Chapetón de acero inoxidable



FIGURA 24-TG **ACABADO** CROMO **CONT. MASTER** 20 **PRECIO UNITARIO** \$784.65



- Maneral cruceta
- Cuerpo de bronce
- Pico de acero inoxidable
- Chapetón de acero inoxidable



FIGURA 24-TH **ACABADO** CROMO **CONT. MASTER** 20 **PRECIO UNITARIO** \$914.37



- Maneral acrílico
- Cuerpo de bronce
- Pico de acero inoxidable
- Chapetón de acero inoxidable



FIGURA 24-TL **ACABADO** CROMO **CONT. MASTER** 20 **PRECIO UNITARIO** \$677.61



- Maneral palanca
- Cuerpo de bronce
- Pico de acero inoxidable
- Chapetón de acero inoxidable



FIGURA 24-TP **ACABADO** CROMO **CONT. MASTER** 20 **PRECIO UNITARIO** \$692.90

Estos precios **NO** incluyen I.V.A.-Esta lista sustituye a las anteriores-Sujetos a cambios sin previo aviso.

La información e imágenes contenidas pueden sufrir cambios sin previo aviso, por motivos de actualización y mejora continua sin responsabilidad alguna por la marca o su publicidad

MEZCLADORAS LAVABO 4" CIERRE 90°



- Maneral rhin
- Cuerpo de bronce
- Pico de acero inoxidable
- Chapetón de acero inoxidable



- Maneral sena
- Cuerpo de bronce
- Pico de acero inoxidable
- Chapetón de acero inoxidable



FIGURA	ACABADO	CONT. MASTER	PRECIO UNITARIO	FIGURA	ACABADO	CONT. MASTER	PRECIO UNITARIO
24-TR	CROMO	20	\$721.37	24-TS	CROMO	20	\$721.37



MEZCLADORAS LAVABO 4" TIPO BAR



- Maneral palanca
- Cuerpo de latón
- Pico de latón
- Chapetón de latón



- Maneral palanca
- Cuerpo de bronce
- Pico de acero inoxidable
- Chapetón de acero inoxidable



FIGURA	ACABADO	CONT. MASTER	PRECIO UNITARIO	FIGURA	ACABADO	CONT. MASTER	PRECIO UNITARIO
24-BO	CROMO-LATÓN	20	\$1,532.91	24-BP	CROMO	20	\$709.35



- Maneral palanca
- Cuerpo de latón
- Pico de latón
- Chapetón de latón



- Maneral minimalista
- Cuerpo de bronce
- Pico de acero inoxidable
- Chapetón de acero inoxidable



FIGURA	ACABADO	CONT. MASTER	PRECIO UNITARIO	FIGURA	ACABADO	CONT. MASTER	PRECIO UNITARIO
24-BT	CROMO	10	\$1,623.08	24-CC	CROMO	20	\$996.63

Estos precios **NO** incluyen I.V.A.-Esta lista sustituye a las anteriores-Sujetos a cambios sin previo aviso.
 La información e imágenes contenidas pueden sufrir cambios sin previo aviso, por motivos de actualización y mejora continua sin responsabilidad alguna por la marca o su publicidad

MEZCLADORAS LAVABO 4" TIPO BAR



- Maneral cruceta
- Cuerpo de bronce
- Pico de acero inoxidable
- Chapetón de acero inoxidable



FIGURA 24-CRB **ACABADO** CROMO **CONT. MASTER** 20 **PRECIO UNITARIO** \$919.75



- Maneral minimalista
- Cuerpo de latón
- Pico de acero inoxidable
- Chapetón de acero inoxidable



FIGURA 24-CS **ACABADO** SATINADO **CONT. MASTER** 20 **PRECIO UNITARIO** \$1,755.34



- Maneral tauro
- Cuerpo de bronce
- Pico de acero inoxidable
- Chapetón de acero inoxidable



FIGURA 24-IB **ACABADO** CROMO **CONT. MASTER** 20 **PRECIO UNITARIO** \$718.36



- Maneral acrílico
- Cuerpo de latón
- Pico de acero inoxidable
- Chapetón de acero inoxidable



FIGURA 24-IBL **ACABADO** CROMO **CONT. MASTER** 20 **PRECIO UNITARIO** \$718.21



- Maneral palanca
- Cuerpo de bronce
- Pico de acero inoxidable
- Chapetón de acero inoxidable



FIGURA 24-ID **ACABADO** CROMO **CONT. MASTER** 20 **PRECIO UNITARIO** \$901.71



- Maneral géminis
- Cuerpo de bronce
- Pico de acero inoxidable
- Chapetón de acero inoxidable



FIGURA 24-IG **ACABADO** CROMO **CONT. MASTER** 20 **PRECIO UNITARIO** \$862.64



- Maneral piruli
- Cuerpo de latón
- Pico de latón
- Chapetón de latón



FIGURA 24-IP **ACABADO** CROMO **CONT. MASTER** 20 **PRECIO UNITARIO** \$851.09



- Maneral rhin
- Cuerpo de bronce
- Pico de acero inoxidable
- Chapetón de acero inoxidable



FIGURA 24-IR **ACABADO** CROMO **CONT. MASTER** 20 **PRECIO UNITARIO** \$790.98



- Maneral sena
- Cuerpo de latón
- Pico de latón
- Chapetón de latón



FIGURA 24-IS **ACABADO** CROMO **CONT. MASTER** 10 **PRECIO UNITARIO** \$790.98



- Maneral magnum
- Cuerpo de bronce
- Pico de acero inoxidable
- Chapetón de acero inoxidable



FIGURA 24-LC **ACABADO** CROMO-LATÓN **CONT. MASTER** 20 **PRECIO UNITARIO** \$1,477.54

Estos precios **NO** incluyen I.V.A.-Esta lista sustituye a las anteriores-Sujetos a cambios sin previo aviso.

La información e imágenes contenidas pueden sufrir cambios sin previo aviso, por motivos de actualización y mejora continua sin responsabilidad alguna por la marca o su publicidad

MEZCLADORAS

LAVABO 4" TIPO BAR



- Maneral cuadro
- Cuerpo de bronce
- Pico de acero inoxidable
- Chapetón de acero inoxidable



- Maneral palanca
- Cuerpo de latón
- Pico de latón
- Chapetón de latón



FIGURA 24-ML ACABADO CROMO CONT. MASTER 20 PRECIO UNITARIO \$1,758.34

FIGURA 24-PA ACABADO CROMO CONT. MASTER 20 PRECIO UNITARIO \$1,229.34

MEZCLADORAS

LAVABO A LA PARED



- Maneral minimalista
- Cuerpo de latón
- Pico de latón

-40% EXTRA



- Maneral palanca
- Cuerpo de latón
- Pico de latón

-40% EXTRA



FIGURA 190-RC ACABADO CROMO CONT. MASTER 6 PRECIO UNITARIO \$4,751.74

FIGURA 190-RP ACABADO CROMO CONT. MASTER 6 PRECIO UNITARIO \$6,768.13



- Maneral palanca
- Cuerpo de latón
- Pico de latón

-40% EXTRA



FIGURA 190-RS ACABADO SATINADO CONT. MASTER 6 PRECIO UNITARIO \$7,645.64

MEZCLADORAS

LAVABO DE 8" A 12"



- Maneral cruceta
- Cuerpo de latón
- Sin desagüe automático

-40% EXTRA



- Maneral asia
- Cuerpo de latón
- Con desagüe automático

-40% EXTRA



FIGURA 091-RC ACABADO CROMO CONT. MASTER 6 PRECIO UNITARIO \$9,407.12

FIGURA 19-A ACABADO CROMO-LATÓN CONT. MASTER 6 PRECIO UNITARIO \$5,432.81



- Maneral asia
- Cuerpo de latón
- Con desagüe automático

-40% EXTRA



- Maneral cruceta
- Cuerpo de bronce
- Sin desagüe automático



FIGURA 19-AC ACABADO CROMO CONT. MASTER 6 PRECIO UNITARIO \$8,784.89

FIGURA 19-FCS ACABADO CROMO CONT. MASTER 10 PRECIO UNITARIO \$3,417.02

Estos precios **NO** incluyen I.V.A.-Esta lista sustituye a las anteriores-Sujetos a cambios sin previo aviso.

La información e imágenes contenidas pueden sufrir cambios sin previo aviso, por motivos de actualización y mejora continua sin responsabilidad alguna por la marca o su publicidad

MEZCLADORAS LAVABO DE 8" A 12"



- Maneral asia
- Cuerpo de latón
- Con desagüe automático

FIGURA 19-GH **ACABADO CROMO-LATÓN** **CONT. MASTER 6** **PRECIO UNITARIO \$8,225.54**

-40% EXTRA



- Maneral rumania
- Cuerpo de latón
- Con desagüe automático

FIGURA 19-GRC **ACABADO CROMO** **CONT. MASTER 6** **PRECIO UNITARIO \$6,863.20**

-40% EXTRA



- Maneral asia
- Cuerpo de latón
- Con desagüe automático

FIGURA 19-H **ACABADO CROMO-LATÓN** **CONT. MASTER 6** **PRECIO UNITARIO \$5,510.15**

-40% EXTRA



- Maneral acuario
- Cuerpo de latón
- Con desagüe automático

FIGURA 19-I **ACABADO CROMO** **CONT. MASTER 10** **PRECIO UNITARIO \$3,515.10**



- Maneral acuario
- Cuerpo de bronce
- Con desagüe automático

FIGURA 19-IB **ACABADO CROMO** **CONT. MASTER 10** **PRECIO UNITARIO \$3,822.00**





- Maneral acuario
- Cuerpo de bronce
- Sin desagüe automático

FIGURA 19-IBS **ACABADO CROMO** **CONT. MASTER 10** **PRECIO UNITARIO \$3,068.99**





- Maneral cruceta
- Cuerpo de bronce
- Sin desagüe automático

FIGURA 19-ICS **ACABADO CROMO** **CONT. MASTER 10** **PRECIO UNITARIO \$3,448.66**





- Maneral acuario
- Cuerpo de bronce
- Sin desagüe automático

FIGURA 19-IS **ACABADO CROMO** **CONT. MASTER 10** **PRECIO UNITARIO \$3,148.09**





- Maneral asia
- Cuerpo de latón
- Lisboa
- Con desagüe automático

FIGURA 19-LA **ACABADO CROMO-LATÓN** **CONT. MASTER 6** **PRECIO UNITARIO \$5,359.66**

-40% EXTRA



- Maneral asia
- Cuerpo de latón
- Lisboa
- Con desagüe automático

FIGURA 19-LG **ACABADO CROMO-LATÓN** **CONT. MASTER 6** **PRECIO UNITARIO \$8,423.93**

-40% EXTRA



Estos precios **NO** incluyen I.V.A.-Esta lista sustituye a las anteriores-Sujetos a cambios sin previo aviso.
La información e imágenes contenidas pueden sufrir cambios sin previo aviso, por motivos de actualización y mejora continua sin responsabilidad alguna por la marca o su publicidad

MEZCLADORAS LAVABO DE 8" A 12"

- Maneral rumania
- Cuerpo de latón
- Lisboa
- Con desagüe automático



FIGURA 19-R **ACABADO CROMO-LATÓN** **CONT. MASTER 6** **PRECIO UNITARIO \$6,198.91**

-40% EXTRA



- Maneral cruceta
- Cuerpo de latón
- Con desagüe automático



FIGURA 19-SC **ACABADO SATINADO** **CONT. MASTER 6** **PRECIO UNITARIO \$8,432.93**

-40% EXTRA



- Maneral asia
- Cuerpo de latón
- Con desagüe automático



FIGURA 19-VA **ACABADO CROMO-LATÓN** **CONT. MASTER 6** **PRECIO UNITARIO \$9,496.78**

-40% EXTRA



- Maneral asia
- Cuerpo de latón
- Con desagüe automático



FIGURA 19-VAC **ACABADO CROMO** **CONT. MASTER 6** **PRECIO UNITARIO \$7,700.11**

-40% EXTRA



- Maneral minimalista
- Cuerpo de latón
- Con desagüe automático



FIGURA 19-VC **ACABADO CROMO-LATÓN** **CONT. MASTER 6** **PRECIO UNITARIO \$9,067.47**

-40% EXTRA



- Maneral acuario
- Cuerpo de latón
- Con desagüe automático



FIGURA 19-VCC **ACABADO CROMO** **CONT. MASTER 6** **PRECIO UNITARIO \$8,703.43**

-40% EXTRA



- Maneral asia
- Cuerpo de latón
- Con desagüe automático





FIGURA 19-VH **ACABADO CROMO-LATÓN** **CONT. MASTER 6** **PRECIO UNITARIO \$9,492.11**

-40% EXTRA



- Maneral asia
- Cuerpo de latón
- Con desagüe automático



FIGURA 19-VHC **ACABADO CROMO** **CONT. MASTER 6** **PRECIO UNITARIO \$9,095.45**

-40% EXTRA



- Maneral rumania
- Cuerpo de latón
- Con desagüe automático



FIGURA 19-VR **ACABADO CROMO-LATÓN** **CONT. MASTER 6** **PRECIO UNITARIO \$9,552.82**

-40% EXTRA



- Maneral Rumania
- Cuerpo de latón
- Con desagüe automático



FIGURA 19-VRC **ACABADO CROMO** **CONT. MASTER 6** **PRECIO UNITARIO \$8,236.76**

-40% EXTRA



Estos precios **NO** incluyen I.V.A.-Esta lista sustituye a las anteriores-Sujetos a cambios sin previo aviso.
La información e imágenes contenidas pueden sufrir cambios sin previo aviso, por motivos de actualización y mejora continua sin responsabilidad alguna por la marca o su publicidad

MEZCLADORAS

LAVABO DE 8" A 12"



- Maneral rumania
- Cuerpo de latón
- Con desagüe automático

-40%
EXTRA



DESAGÜE

- Material de latón
- Para mezcladora de lavabo
- Automático

FIGURA
19-VSR

ACABADO
SATINADO

CONT. MASTER
6

PRECIO UNITARIO
\$9,370.79

FIGURA
RI-51

ACABADO
CROMO

CONT. MASTER
50

PRECIO UNITARIO
\$594.81



Estos precios **NO** incluyen I.V.A.-Esta lista sustituye a las anteriores-Sujetos a cambios sin previo aviso.

La información e imágenes contenidas pueden sufrir cambios sin previo aviso, por motivos de actualización y mejora continua sin responsabilidad alguna por la marca o su publicidad

LLAVES INDIVIDUALES LAVABO



- Maneral tauro
- Cuerpo de bronce



FIGURA 16-B ACABADO CROMO CONT. MASTER 30 PRECIO UNITARIO \$627.47



- Maneral cruceta
- Cuerpo de bronce



FIGURA 16-BC ACABADO CROMO CONT. MASTER 30 PRECIO UNITARIO \$627.47



- Maneral acuario
- Cuerpo de latón



FIGURA 16-I ACABADO CROMO CONT. MASTER 50 PRECIO UNITARIO \$595.13



- Maneral tauro
- Cuerpo de latón



FIGURA 16-Q ACABADO CROMO CONT. MASTER 40 PRECIO UNITARIO \$429.82



- Maneral tauro
- Cuerpo de bronce



FIGURA 16-R ACABADO CROMO CONT. MASTER 20 PRECIO UNITARIO \$569.58



- Maneral cruceta
- Cuerpo de bronce



FIGURA 16-RC ACABADO CROMO CONT. MASTER 25 PRECIO UNITARIO \$531.54

LLAVE SENSOR LAVABO



- De sensor
- Material de latón



FIGURA 16-SE FIGURA LLAVE INDIVIDUAL CONT. MASTER 10 PRECIO UNITARIO \$6,580.92

Trabaja con corriente 110 volts y/o 4 baterías "AA" baterías incluidas.

Estos precios **NO** incluyen I.V.A.-Esta lista sustituye a las anteriores-Sujetos a cambios sin previo aviso.

La información e imágenes contenidas pueden sufrir cambios sin previo aviso, por motivos de actualización y mejora continua sin responsabilidad alguna por la marca o su publicidad

LLAVE PARA BEBEDERO



- Cuerpo de latón
- Resorte



- Cuerpo de latón
- Botón de push

FIGURA	ACABADO	CONT. MASTER	PRECIO UNITARIO	FIGURA	ACABADO	CONT. MASTER	PRECIO UNITARIO
16-BB	CROMO	20	\$1,797.10	16-BP	CROMO	20	\$1,307.48



- Cuerpo de latón
- Botón de push



- Cuerpo de latón
- Botón de push

FIGURA	ACABADO	CONT. MASTER	PRECIO UNITARIO	FIGURA	ACABADO	CONT. MASTER	PRECIO UNITARIO
16-T	CROMO	17	\$3,546.74	17-T	CROMO	20	\$1,939.22

TRAMPAS COMPLETAS LAVABO

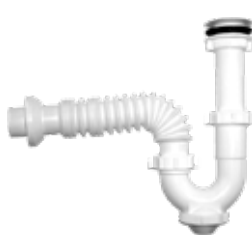

- Salida flexible
- Material de polipropileno
- Diámetro de 1 1/2"
- Con registro



- Tubo de latón
- Diámetro de 1 1/4"
- Con registro



FIGURA	CONT. MASTER	PRECIO UNITARIO	FIGURA	ACABADO	CONT. MASTER	PRECIO UNITARIO
10-RF	50	\$135.32	28-B	CROMO	20	\$705.55



- Flexible
- Material de polipropileno
- Diámetro de 1 1/4"
- Sin registro



- Tubo de latón
- Diámetro de 1 1/4"
- Sin registro
- Contra reforzada



FIGURA	CONT. MASTER	PRECIO UNITARIO	FIGURA	ACABADO	CONT. MASTER	PRECIO UNITARIO
28-PTF	60	\$97.83	29	CROMO	20	\$616.36



- Tubo de latón
- Diámetro de 1 1/4"
- Sin registro
- Contra tubular



- Tubo de acero inoxidable
- Diámetro de 1 1/4"
- Sin registro

FIGURA	ACABADO	CONT. MASTER	PRECIO UNITARIO	FIGURA	ACABADO	CONT. MASTER	PRECIO UNITARIO
29-B	CROMO	20	\$610.16	29-BA	CROMO	40	\$526.00

Estos precios **NO** incluyen I.V.A.-Esta lista sustituye a las anteriores-Sujetos a cambios sin previo aviso.
La información e imágenes contenidas pueden sufrir cambios sin previo aviso, por motivos de actualización y mejora continua sin responsabilidad alguna por la marca o su publicidad

TRAMPAS COMPLETAS LAVABO



- Tubo de latón
- Diámetro de 1 1/4"
- Sin registro



FIGURA 29-C **ACABADO SATINADO** **CONT. MASTER 20** **PRECIO UNITARIO \$565.07**



- Tubo de latón
- Diámetro de 1 1/2"
- Sin registro
- Al piso



FIGURA 29-H **ACABADO CROMO** **CONT. MASTER 25** **PRECIO UNITARIO \$1,294.04**



- Tubo de latón
- Diámetro de 1 1/4"
- Con registro

FIGURA 29-L **CONT. MASTER 20** **PRECIO UNITARIO \$1,414.76**



- Material de P.V.C
- Diámetro de 1 1/4"
- Con registro



FIGURA 29-P **CONT. MASTER 50** **PRECIO UNITARIO \$115.13**



- Material de P.V.C
- Diámetro de 1 1/4"
- Con registro



FIGURA 29-PL **CONT. MASTER 50** **PRECIO UNITARIO \$130.16**



- Material de polipropileno
- Diámetro de 1 1/4"
- Con registro



FIGURA 29-R **CONT. MASTER 50** **PRECIO UNITARIO \$104.60**



- Salida flexible
- Material de polipropileno
- Diámetro de 1 1/4"
- Con registro



FIGURA 29-RF **CONT. MASTER 40** **PRECIO UNITARIO \$126.40**



- Tubo de latón
- Diámetro de 1 1/4"
- Sin registro
- Cierre de tapón giratorio



FIGURA 29-T **CONT. MASTER 20** **PRECIO UNITARIO \$637.21**

MEDIAS TRAMPAS LAVABO



- Salida flexible
- Material de polipropileno
- Diámetro de 1 1/2"
- Con registro



FIGURA 10-LF **CONT. MASTER 60** **PRECIO UNITARIO \$98.08**



- Flexible
- Material de polipropileno
- Diámetro de 1 1/2"
- Sin registro



FIGURA 11-PTF **CONT. MASTER 70** **PRECIO UNITARIO \$80.84**

Estos precios **NO** incluyen I.V.A.-Esta lista sustituye a las anteriores-Sujetos a cambios sin previo aviso.

La información e imágenes contenidas pueden sufrir cambios sin previo aviso, por motivos de actualización y mejora continua sin responsabilidad alguna por la marca o su publicidad

MEDIAS TRAMPAS LAVABO



- Material de polipropileno
- Diámetro de 1 1/2"
- Con registro



FIGURA 11-R

CONT. MASTER 60

PRECIO UNITARIO \$66.44



- Material de P.V.C
- Diámetro de 1 1/4"
- Sin registro



FIGURA 11-RS

CONT. MASTER 60

PRECIO UNITARIO \$83.84



- Tubo de latón
- Diámetro de 1 1/4"
- Con registro



FIGURA 28-D

ACABADO CROMO

CONT. MASTER 20

PRECIO UNITARIO \$566.34



- Tubo de latón
- Diámetro de 1 1/4"
- Chapetón de acero inoxidable
- Con registro

FIGURA 28-L

ACABADO CROMO

CONT. MASTER 50

PRECIO UNITARIO \$736.40



- Tubo de latón
- Diámetro de 1 1/4"
- Chapetón de acero inoxidable
- Con registro

FIGURA 28-LC

ACABADO CROMO

CONT. MASTER 20

PRECIO UNITARIO \$1,053.58



- Material de polipropileno
- Diámetro de 1 1/4"
- Sin registro

FIGURA 28-PT

CONT. MASTER 100

PRECIO UNITARIO \$50.62



- Tubo de latón
- Diámetro de 1 1/4"
- Chapetón de acero inoxidable
- Sin registro

FIGURA 29-D

ACABADO CROMO

CONT. MASTER 50

PRECIO UNITARIO \$423.96



- Tubo de acero inoxidable
- Diámetro de 1 1/4"
- Chapetón de acero inoxidable
- Sin registro

FIGURA 29-DA

ACABADO CROMO

CONT. MASTER 50

PRECIO UNITARIO \$357.68

CONTRAS LAVABO



- Tubo de latón
- Diámetro de 1 1/4"
- Tuerca de bronce
- Con rebosadero
- Medida 32mm



FIGURA 30

ACABADO CROMO

CONT. MASTER 126

PRECIO UNITARIO \$297.41



- Tubo de latón
- Diámetro de 1 1/4"
- Tuerca metálica
- Con rebosadero
- Medida 32mm

FIGURA 30-B

ACABADO CROMO

CONT. MASTER 126

PRECIO UNITARIO \$198.38

Estos precios **NO** incluyen I.V.A.-Esta lista sustituye a las anteriores-Sujetos a cambios sin previo aviso.
La información e imágenes contenidas pueden sufrir cambios sin previo aviso, por motivos de actualización y mejora continua sin responsabilidad alguna por la marca o su publicidad

CONTRAS LAVABO



- Tubo de latón
- Diámetro de 1 1/4"
- Tuerca de bronce
- Sin rebosadero



FIGURA 30-C **ACABADO** CROMO **CONT. MASTER** 126 **PRECIO UNITARIO** \$310.06



- Tubo de latón
- Diámetro de 1 1/4"
- Tuerca metálica
- Con rebosadero

FIGURA 30-L **ACABADO** CROMO **CONT. MASTER** 50 **PRECIO UNITARIO** \$264.15



- Con rebosadero 30-LER
2 3/8" x 26 cm x 1 1/4"
- Sin rebosadero 30-LES
2 3/8" x 26 cm x 1 1/4"

FIGURA 30-LER **ACABADO** CROMO **CONT. MASTER** 50 **PRECIO UNITARIO** \$468.26
FIGURA 30-LES **ACABADO** CROMO **CONT. MASTER** 50 **PRECIO UNITARIO** \$468.26



- De Push
- Tubo de latón
- Diámetro de 1 1/4" tapa
- Tuerca de latón
- Con rebosadero

FIGURA 30-LPR **ACABADO** CROMO **CONT. MASTER** 50 **PRECIO UNITARIO** \$422.79



- De Push
- Tubo de latón
- Diámetro de 1 1/4" tapa
- Tuerca de latón
- Sin rebosadero

FIGURA 30-LPS **ACABADO** CROMO **CONT. MASTER** 50 **PRECIO UNITARIO** \$430.29



- Rejilla de acero inoxidable
- Tubo de polipropileno
- Diámetro de 1 1/4"
- Tuerca de polipropileno
- Medida 32mm

FIGURA 30-PA **CONT. MASTER** 100 **PRECIO UNITARIO** \$90.14



- Tubo de P.V.C.
- Diámetro de 1 1/4"
- Tuerca de P.V.C

FIGURA 30-PR **CONT. MASTER** 150 **PRECIO UNITARIO** \$34.42



- Tubo de latón
- Diámetro de 1 1/4"
- Tuerca de bronce
- Tapón giratorio
- Con rebosadero

FIGURA 30-T **ACABADO** CROMO **CONT. MASTER** 100 **PRECIO UNITARIO** \$287.32

EXTENSIÓN LAVABO



- Tubo de latón
- Diámetro de 32 mm
- Largo 15 cms



FIGURA 31 **ACABADO** CROMO **CONT. MTR** 100 **PRECIO UNIT.** \$171.33



- Tubo de polipropileno
- Diámetro de 32 mm
- Largo 20 cms



FIGURA 31-PR **CONT. MTR** 250 **PRECIO UNIT.** \$23.75



- Medida de 2" x 1 1/4"
- Material de vinilo



FIGURA 29-U **CONT. MTR** 1000 **PRECIO UNIT.** \$15.06

Estos precios **NO** incluyen I.V.A.-Esta lista sustituye a las anteriores-Sujetos a cambios sin previo aviso.

La información e imágenes contenidas pueden sufrir cambios sin previo aviso, por motivos de actualización y mejora continua sin responsabilidad alguna por la marca o su publicidad

CUBRETALADROS

- Fig. 26 *acero inoxidable
- Fig. 26-A *aluminio



FIGURA	ACABADO	CONT. MTR	PRECIO UNIT.
26	CROMO	1000	\$25.66
26-A	CROMO	1000	\$21.45

- Material de acero inoxidable



FIGURA	ACABADO	CONT. MTR	PRECIO UNIT.
26-T	CROMO	1000	\$30.88

- Material de acero inoxidable



FIGURA	ACABADO	CONT. MTR	PRECIO UNIT.
B26P	CROMO	1000	\$33.32

MONOMANDO REGADERA

- Material de latón
- Para regadera y/o tina



FIGURA	ACABADO	CONT. MASTER	PRECIO UNITARIO
34-MC	CROMO	10	\$1,575.63

- Material de latón
- Para regadera y/o tina



FIGURA	ACABADO	CONT. MASTER	PRECIO UNITARIO
34-MCC	CROMO	12	\$1,936.31

- Material de latón
- Para regadera y/o tina



FIGURA	ACABADO	CONT. MASTER	PRECIO UNITARIO
34-MCO	CROMO	12	\$1,614.07

- Material de latón
- Para regadera y/o tina



FIGURA	ACABADO	CONT. MASTER	PRECIO UNITARIO
34-MQ	CROMO	12	\$1,259.39

- Material de latón
- Para regadera y/o tina



FIGURA	ACABADO	CONT. MTR	PRECIO UNIT.
34-MS	SATINADO	10	\$1,971.21

- Material de latón
- Para regadera y/o tina



FIGURA	ACABADO	CONT. MTR	PRECIO UNIT.
34-MT	CROMO	12	\$1,442.74

- Material de latón
- Para regadera y/o tina



FIGURA	ACABADO	CONT. MTR	PRECIO UNIT.
36-MM	CROMO	10	\$2,088.18

- Material de latón
- Para regadera y/o tina



FIGURA	ACABADO	CONT. MTR	PRECIO UNIT.
37-MM	CROMO	10	\$1,553.48

- Material de latón
- Para regadera y/o tina



FIGURA	ACABADO	CONT. MTR	PRECIO UNIT.
37-MPL	CROMO	10	\$1,487.04

- Material de latón
- Para regadera y/o tina



FIGURA	ACABADO	CONT. MTR	PRECIO UNIT.
108-RM	CROMO	10	\$1,709.35

Estos precios **NO** incluyen I.V.A.-Esta lista sustituye a las anteriores-Sujetos a cambios sin previo aviso.

La información e imágenes contenidas pueden sufrir cambios sin previo aviso, por motivos de actualización y mejora continua sin responsabilidad alguna por la marca o su publicidad

MEZCLADORA DE EMPOTRAR

- Maneral palanca
- Cuerpo de latón
- Conexión roscable o soldable
- Para regadera y/o tina



-40% EXTRA



FIGURA ACABADO CONT. MASTER PRECIO UNITARIO
36-AC CROMO 6 \$5,754.04

- Maneral palanca
- Cuerpo de bronce
- Conexión roscable o soldable
- Para regadera y/o tina



-40% EXTRA



FIGURA ACABADO CONT. MASTER PRECIO UNITARIO
36-AO CROMO-LATÓN 6 \$6,482.65

- Maneral acuario
- Cuerpo de bronce
- Conexión roscable o soldable
- Para regadera y/o tina





FIGURA ACABADO CONT. MTR PRECIO UNIT.
36-I CROMO 10 \$1,869.55

- Kit para regadera INCLUYE:
 *Regadera
 *Brazo
 *Mezcladora p/empotrar
 *Manerales acuario





FIGURA ACABADO CONT. MTR PRECIO UNIT.
36-IAN CROMO 10 \$2,151.58

- Maneral minimalista
- Cuerpo de bronce
- Conexión roscable o soldable
- Para regadera y/o tina





FIGURA ACABADO CONT. MTR PRECIO UNIT.
36-ICM CROMO 10 \$1,990.10

- Maneral capri
- Cuerpo de bronce
- Conexión roscable o soldable
- Para regadera y/o tina





FIGURA ACABADO CONT. MTR PRECIO UNIT.
36-ICR CROMO 10 \$1,990.10

- Maneral géminis
- Cuerpo de bronce
- Conexión roscable o soldable
- Para regadera y/o tina





FIGURA ACABADO CONT. MTR PRECIO UNIT.
36-IG CROMO 10 \$1,980.29

- Maneral pirulí
- Cuerpo de bronce
- Conexión roscable o soldable
- Para regadera y/o tina







FIGURA ACABADO CONT. MTR PRECIO UNIT.
36-IP CROMO 10 \$1,953.71

- Sin manerales
- Cuerpo de bronce
- Conexión roscable o soldable
- Para regadera y/o tina





FIGURA CONT. MTR PRECIO UNIT.
36-IS 10 \$1,538.41

- Maneral redondo
- Cuerpo de latón
- Conexión roscable
- Para regadera



FIGURA ACABADO CONT. MTR PRECIO UNIT.
36-PF CROMO 10 \$2,467.85

- Maneral acuario
- Cuerpo de bronce
- Conexión roscable o soldable
- Para regadera y/o tina





FIGURA ACABADO CONT. MTR PRECIO UNIT.
36-PM CROMO 10 \$2,018.57

- Maneral tauro
- Cuerpo de bronce
- Conexión roscable o soldable
- Para regadera





FIGURA ACABADO CONT. MTR PRECIO UNIT.
36-R CROMO 10 \$1,736.98

- Sin manerales
- Cuerpo de bronce
- Conexión roscable o soldable
- Para regadera y tina





FIGURA CONT. MTR PRECIO UNIT.
36-RCC 10 \$2,097.99

- Sin manerales
- Cuerpo de bronce
- Conexión roscable o soldable
- Para regadera y/o tina





FIGURA CONT. MTR PRECIO UNIT.
36-THS 10 \$1,776.38

Estos precios **NO** incluyen I.V.A.-Esta lista sustituye a las anteriores-Sujetos a cambios sin previo aviso.

La información e imágenes contenidas pueden sufrir cambios sin previo aviso, por motivos de actualización y mejora continua sin responsabilidad alguna por la marca o su publicidad

LLAVES INDIVIDUALES

REGADERA CIERRE 90° ROSCABLE

- Maneral tauro
- Roscable



FIGURA ACABADO CONT. MTR PRECIO UNIT.
34-I CROMO 20 \$838.44

- Sin manerales
- Roscable



FIGURA ACABADO CONT. MTR PRECIO UNIT.
38-EC CROMO 20 \$737.19

- Maneral acuario
- Roscable



FIGURA ACABADO CONT. MTR PRECIO UNIT.
38-IC CROMO 20 \$946.01

- Maneral géminis
- Material de bronce
- Roscable



FIGURA ACABADO CONT. MTR PRECIO UNIT.
38-IG CROMO 20 \$1,237.09

- Maneral minimalista
- Roscable



FIGURA ACABADO CONT. MTR PRECIO UNIT.
38-IM CROMO 20 \$1,167.48

- Maneral palanca
- Material de bronce
- Roscable



FIGURA ACABADO CONT. MTR PRECIO UNIT.
38-MT CROMO 20 \$1,173.73

- Maneral cruceta
- Roscable



FIGURA ACABADO CONT. MASTER PRECIO UNITARIO
40-CR CROMO 20 \$1,246.58

- Maneral pirulí
- Roscable



FIGURA ACABADO CONT. MASTER PRECIO UNITARIO
40-P CROMO 20 \$1,161.15

LLAVES INDIVIDUALES

REGADERA CIERRE 90° SOLDABLE

- Maneral tauro
- Soldable



FIGURA ACABADO CONT. MTR PRECIO UNIT.
35-I CROMO 20 \$715.04

- Sin manerales
- Soldable



FIGURA ACABADO CONT. MTR PRECIO UNIT.
39-EC CROMO 20 \$721.37

- Maneral acuario
- Soldable



FIGURA ACABADO CONT. MTR PRECIO UNIT.
39-IC CROMO 20 \$1,059.91

Estos precios **NO** incluyen I.V.A.-Esta lista sustituye a las anteriores-Sujetos a cambios sin previo aviso.

La información e imágenes contenidas pueden sufrir cambios sin previo aviso, por motivos de actualización y mejora continua sin responsabilidad alguna por la marca o su publicidad

LLAVES INDIVIDUALES

REGADERA CIERRE 90° SOLDABLE

- Maneral minimalista
- Soldable



FIGURA ACABADO CONT. MTR PRECIO UNIT.
39-IM CROMO 20 \$1,104.20

- Maneral cruceta
- Soldable



FIGURA ACABADO CONT. MTR PRECIO UNIT.
41-CR CROMO 20 \$1,227.60

- Maneral pirulif
- Soldable



FIGURA ACABADO CONT. MTR PRECIO UNIT.
41-P CROMO 20 \$1,104.20

LLAVES INDIVIDUALES REGADERA CIERRE COMPRESIÓN ROSCABLE

- Maneral tauro
- Material de bronce
- Roscable



FIGURA ACABADO CONT. MASTER PRECIO UNITARIO
32-I CROMO 20 \$762.50

- Maneral asia
- Material de latón
- Roscable



FIGURA ACABADO CONT. MASTER PRECIO UNITARIO
38-GCE CROMO 20 \$807.77

- Maneral tauro
- Material de bronce
- Roscable



FIGURA ACABADO CONT. MASTER PRECIO UNITARIO
38-I CROMO 20 \$914.37

- Maneral rhin
- Material de bronce
- Roscable



FIGURA ACABADO CONT. MASTER PRECIO UNITARIO
38-IR CROMO 20 \$852.13

- Maneral sena
- Material de bronce
- Roscable



FIGURA ACABADO CONT. MASTER PRECIO UNITARIO
38-IS CROMO 20 \$852.13

- Maneral tauro
- Material de bronce
- Roscable
- Asiento cambiabile



FIGURA ACABADO CONT. MASTER PRECIO UNITARIO
38-Q CROMO 20 \$911.20

- Sin maneral
- Material de bronce
- Roscable



FIGURA CONT. MTR PRECIO UNIT.
40-E 20 \$649.23

- Maneral tauro
- Material de bronce
- Roscable
- Manerales metálicos
- Espiga cuadro



FIGURA ACABADO CONT. MTR PRECIO UNIT.
40-Q CROMO 20 \$870.07

- Maneral acrílico
- Material de bronce
- Roscable



FIGURA CONT. MTR PRECIO UNIT.
40-QL 20 \$931.77

Estos precios **NO** incluyen I.V.A.-Esta lista sustituye a las anteriores-Sujetos a cambios sin previo aviso.

La información e imágenes contenidas pueden sufrir cambios sin previo aviso, por motivos de actualización y mejora continua sin responsabilidad alguna por la marca o su publicidad

LLAVES INDIVIDUALES REGADERA

CIERRE COMPRESIÓN SOLDABLE

- Material de bronce
- Para tubo C.P.V.C.
- Conexión compresión





FIGURA
32-PVC

ACABADO
CROMO

CONT. MASTER
20

PRECIO UNITARIO
\$1,088.38



- Maneral tauro
- Material de bronce
- Soldable



FIGURA
33-I

ACABADO
CROMO

CONT. MASTER
20

PRECIO UNITARIO
\$697.32



- Maneral tauro
- Material de bronce
- Soldable



FIGURA
39-I

ACABADO
CROMO

CONT. MASTER
20

PRECIO UNITARIO
\$829.58



- Maneral rhin
- Material de bronce
- Soldable



FIGURA
39-IR

ACABADO
CROMO

CONT. MASTER
20

PRECIO UNITARIO
\$785.57



- Maneral sena
- Material de bronce
- Soldable



FIGURA
39-IS

ACABADO
CROMO

CONT. MASTER
20

PRECIO UNITARIO
\$785.57



- Maneral tauro
- Material de bronce
- Soldable
- Asiento cambiabile



FIGURA
39-Q

ACABADO
CROMO

CONT. MASTER
20

PRECIO UNITARIO
\$828.94



- Sin maneral
- Material de bronce
- Soldable



FIGURA
41-E

CONT. MASTER
20

PRECIO UNITARIO
\$651.76



- Material de bronce
- Espiga cuadro
- Soldable



FIGURA
41-Q

ACABADO
CROMO

CONT. MASTER
20

PRECIO UNITARIO
\$838.44



- Material de bronce
- Soldable



FIGURA
41-QL

CONT. MASTER
20

PRECIO UNITARIO
\$871.66



Estos precios **NO** incluyen I.V.A.-Esta lista sustituye a las anteriores-Sujetos a cambios sin previo aviso.
La información e imágenes contenidas pueden sufrir cambios sin previo aviso, por motivos de actualización y mejora continua sin responsabilidad alguna por la marca o su publicidad

- Manerales acuario
- Con chapetón
- Acabado cromo



FIGURA	ENSAMBLE	CONT.	MTR	PRECIO UNIT.
CHMC	CUADRO	80		\$313.23
CHME	ESTRÍA	80		\$282.54

- Manerales tauro
- Con chapetón
- Acabado cromo



FIGURA	ENSAMBLE	CONT.	MTR	PRECIO UNIT.
CHTEC	CUADRO	100		\$294.78
CHTEE	ESTRÍA	50		\$279.53

- Para figura 36-PF
- Ensamble estría



FIGURA	ACABADO	CONT.	MTR	PRECIO UNIT.
M-36P	CROMO	50		\$334.60

- Manerales asia
- Material de latón
- Ensamble cuadro



-40%
EXTRA

FIGURA	ACABADO	CONT.	MTR	PRECIO UNIT.
MAC	CROMO-LATÓN	100		\$1,802.79

- Manerales asia
- Material de latón
- Ensamble estría



FIGURA	ACABADO	CONT.	MTR	PRECIO UNIT.
MACE	CROMO	10		\$1,496.84

- Manerales capri
- Material de latón
- Ensamble estría



FIGURA	ACABADO	CONT.	MTR	PRECIO UNIT.
MCCE	CROMO	10		\$1,728.28

- Manerales minimalista
- Material de latón
- Con chapetón
- Ensamble estría



FIGURA	ACABADO	CONT.	MTR	PRECIO UNIT.
MCCM	CROMO	40		\$1,556.64

- Manerales capri
- Material de latón
- Ensamble estría



FIGURA	ACABADO	CONT.	MTR	PRECIO UNIT.
MCE	CROMO-LATÓN	18		\$2,198.91

-40%
EXTRA

- Manerales capri
- Material de latón
- Ensamble estría



FIGURA	ACABADO	CONT.	MTR	PRECIO UNIT.
MCES	SATINADO	10		\$2,062.87

- Manerales minimalista
- Material de A.B.S.
- Con chapetón
- Ensamble estría



FIGURA	ACABADO	CONT.	MTR	PRECIO UNIT.
MCME	CROMO	50		\$503.06

- Manerales cruceta
- Ensamble estría



FIGURA	ACABADO	CONT.	MTR	PRECIO UNIT.
MCRE	CROMO	10		\$577.10

- Manerales rhin
- Con chapetón
- Ensamble estría



FIGURA	ACABADO	CONT.	MTR	PRECIO UNIT.
MCRG	CROMO	48		\$318.61

- Manerales sena
- Con chapetón
- Ensamble estría



FIGURA	ACABADO	CONT.	MTR	PRECIO UNIT.
MCSG	CROMO	48		\$321.23

- Manerales noruega
- Material de latón
- Ensamble cuadro



FIGURA	ACABADO	CONT.	MTR	PRECIO UNIT.
MNC	CROMO-LATÓN	10		\$2,020.71

-40%
EXTRA

- Manerales noruega
- Material de latón
- Ensamble cuadro



FIGURA	ACABADO	CONT.	MTR	PRECIO UNIT.
MNCC	CROMO	10		\$1,857.35

-40%
EXTRA

Estos precios **NO** incluyen I.V.A.-Esta lista sustituye a las anteriores-Sujetos a cambios sin previo aviso.

La información e imágenes contenidas pueden sufrir cambios sin previo aviso, por motivos de actualización y mejora continua sin responsabilidad alguna por la marca o su publicidad

- Manerales rumania
- Material de latón
- Acabado latón-blanco



-40%
EXTRA

FIGURA	ENSAMBLE	CONT. MTR	PRECIO UNIT.
MRBC	CUADRO	20	\$1,958.46
MRBE	ESTRÍA	20	\$1,958.46

- Manerales rumania
- Material de latón
- Ensamble cuadro



-40%
EXTRA

FIGURA	ACABADO	CONT. MTR	PRECIO UNIT.
MRC	CROMO-LATÓN	10	\$1,904.32

- Manerales rumania
- Material de latón
- Ensamble cuadro



-40%
EXTRA

FIGURA	ACABADO	CONT. MTR	PRECIO UNIT.
MRCC	CROMO	10	\$1,510.65

- Manerales rumania
- Material de latón
- Acabado latón-negro



-40%
EXTRA

FIGURA	ENSAMBLE	CONT. MTR	PRECIO UNIT.
MRNC	CUADRO	20	\$2,020.71
MRNE	ESTRÍA	20	\$2,020.69

- Manerales acuario
- Ensamble cuadro



FIGURA	ACABADO	CONT. MTR	PRECIO UNIT.
RE-04	CROMO	150	\$155.03

- Manerales regio
- Ensamble cuadro



FIGURA	ACABADO	CONT. MTR	PRECIO UNIT.
RE-05	CROMO	100	\$326.93

- Ensamble cuadro



FIGURA	ACABADO	CONT. MTR	PRECIO UNIT.
RE-06	CROMO	150	\$240.46

- Manerales acuario
- Ensamble estría



FIGURA	ACABADO	CONT. MTR	PRECIO UNIT.
RE-12	CROMO	150	\$147.75

- Ensamble estría



FIGURA	ACABADO	CONT. MTR	PRECIO UNIT.
RE-13	CROMO	150	\$207.39

- Manerales tauro
- Acabado cromo



FIGURA	ENSAMBLE	CONT. MTR	PRECIO UNIT.
RE-30	CUADRO	200	\$147.28
RE-31	ESTRÍA	200	\$151.87

- Ensamble estría
- Manerales acrílico color transparente



FIGURA	CONT. MTR	PRECIO UNIT.
RI-32	100	\$155.03

- Manerales nilo color transparente
- Con chapetón acabado cromo
- Ensamble estría



FIGURA	CONT. MTR	PRECIO UNIT.
RI-53	50	\$534.70

- Manerales nilo color humo
- Con chapetón acabado cromo
- Ensamble estría



FIGURA	CONT. MTR	PRECIO UNIT.
RI-55	50	\$534.70

- Manerales nilo color ambar
- Con chapetón acabado cromo
- Ensamble estría



FIGURA	CONT. MTR	PRECIO UNIT.
RI-57	50	\$534.70

- Manerales nilo color azul
- Con chapetón acabado cromo
- Ensamble estría



FIGURA	CONT. MTR	PRECIO UNIT.
RI-59	50	\$534.70

Estos precios **NO** incluyen I.V.A.-Esta lista sustituye a las anteriores-Sujetos a cambios sin previo aviso.

La información e imágenes contenidas pueden sufrir cambios sin previo aviso, por motivos de actualización y mejora continua sin responsabilidad alguna por la marca o su publicidad

- Maneral palanca
- Ensamble roscable



FIGURA ACABADO CONT. MTR PRECIO UNIT.
8R-16 ACRÍLICO 300 \$53.60

- Maneral palanca
- Ensamble roscable



FIGURA ACABADO CONT. MTR PRECIO UNIT.
8R-17 BLANCO 200 \$60.89

- Maneral palanca
- Ensamble roscable



FIGURA ACABADO CONT. MTR PRECIO UNIT.
8R-18 MADERA 600 \$106.21

- Maneral pequin
- Ensamble estría
- Material de latón

**-40%
EXTRA**



FIGURA ACABADO CONT. MTR PRECIO UNIT.
M-PO CROMO-LATÓN 30 \$957.08

- Maneral palanca
- Ensamble estría fina



FIGURA ACABADO CONT. MTR PRECIO UNIT.
M6-LC CROMO 50 \$629.62

- Maneral palanca
- Ensamble estría fina



FIGURA ACABADO CONT. MTR PRECIO UNIT.
M6-LS SATINADO 40 \$708.24

- Maneral palanca
- Ensamble estría



FIGURA ACABADO CONT. MTR PRECIO UNIT.
M7-LC CROMO 40 \$500.84

- Maneral palanca
- Ensamble estría



FIGURA ACABADO CONT. MTR PRECIO UNIT.
M7-LS SATINADO 160 \$527.20

- Manerales cruceta
- Ensamble 1/2 caña



FIGURA ACABADO CONT. MTR PRECIO UNIT.
MCCRC CROMO 50 \$395.49

- Maneral minimalista
- Ensamble estría



FIGURA ACABADO CONT. MTR PRECIO UNIT.
MCML CROMO 10 \$279.53

- Maneral danubio
- Ensamble 20 estrías



FIGURA ACABADO CONT. MTR PRECIO UNIT.
MDL CROMO 40 \$196.16

- Maneral asia
- Material de latón
- Ensamble estría

**-40%
EXTRA**



FIGURA ACABADO CONT. MTR PRECIO UNIT.
ML-A CROMO-LATÓN 50 \$1,274.03

- Maneral holanda
- Material de latón
- Ensamble estría

**-40%
EXTRA**



FIGURA ACABADO CONT. MTR PRECIO UNIT.
ML-H CROMO-LATÓN 30 \$1,273.99

- Maneral noruega
- Material de latón
- Ensamble estría

**-40%
EXTRA**



FIGURA ACABADO CONT. MTR PRECIO UNIT.
ML-N CROMO-LATÓN 30 \$1,437.34

Estos precios **NO** incluyen I.V.A.-Esta lista sustituye a las anteriores-Sujetos a cambios sin previo aviso.

La información e imágenes contenidas pueden sufrir cambios sin previo aviso, por motivos de actualización y mejora continua sin responsabilidad alguna por la marca o su publicidad

- Maneral rumania
- Ensamble estría
- Material de latón



-40%
EXTRA

FIGURA ACABADO CONT. MTR PRECIO UNIT.
ML-R CROMO-LATÓN 100 \$1,073.35

- Maneral asia
- Ensamble estría
- Material de latón



-40%
EXTRA

FIGURA ACABADO CONT. MTR PRECIO UNIT.
MLA-C CROMO 50 \$1,199.34

- Maneral holanda
- Ensamble estría
- Material de latón



-40%
EXTRA

FIGURA ACABADO CONT. MTR PRECIO UNIT.
MLH-C CROMO 30 \$1,124.68

- Maneral noruega
- Ensamble estría
- Material de latón



-40%
EXTRA

FIGURA ACABADO CONT. MTR PRECIO UNIT.
MLN-C CROMO 10 \$1,334.66

- Maneral pequín
- Ensamble estría
- Material de latón



-40%
EXTRA

FIGURA ACABADO CONT. MTR PRECIO UNIT.
MPC CROMO 60 \$957.08

- Maneral pirulí
- Ensamble 20 estrías



FIGURA ACABADO CONT. MTR PRECIO UNIT.
MPL CROMO 30 \$178.21

- Maneral rhin
- Ensamble estría



FIGURA ACABADO CONT. MTR PRECIO UNIT.
MRL CROMO 40 \$159.30

- Maneral sena
- Ensamble estría



FIGURA ACABADO CONT. MTR PRECIO UNIT.
MSL CROMO 100 \$159.30

- Maneral palanca
- Ensamble 20 estrías



FIGURA ACABADO CONT. MTR PRECIO UNIT.
RI-81 CROMO 300 \$90.81

- Maneral cristal
- Color transparente
- Ensamble estría
- Acrílico transparente



FIGURA CONT. MTR PRECIO UNIT.
RI-34 100 \$112.75

- Maneral acrílico
- Ensamble cuadro
- Acrílico humo



-40%
EXTRA

FIGURA CONT. MTR PRECIO UNIT.
RI-46 200 \$154.64

- Maneral nilo
- Color transparente
- Ensamble estría
- Acrílico transparente



FIGURA CONT. MTR PRECIO UNIT.
RI-61 100 \$299.07

- Maneral nilo
- Ensamble estría
- Acrílico humo



FIGURA CONT. MTR PRECIO UNIT.
RI-63 100 \$299.07

- Maneral nilo
- Ensamble estría
- Acrílico azul



FIGURA CONT. MTR PRECIO UNIT.
RI-67 100 \$299.07

Estos precios **NO** incluyen I.V.A.-Esta lista sustituye a las anteriores-Sujetos a cambios sin previo aviso.

La información e imágenes contenidas pueden sufrir cambios sin previo aviso, por motivos de actualización y mejora continua sin responsabilidad alguna por la marca o su publicidad

MANERALES CHICOS

- Maneral niza
- Ensamble estría



FIGURA	ACABADO	CONT. MTR	PRECIO UNIT.
RI-73	CROMO	100	\$167.12

- Maneral acuario
- Ensamble cuadro o estría
- Acabado cromo



FIGURA	ENSAMBLE	CONT. MTR	PRECIO UNIT.
RL-02	CUADRO	200	\$127.60
RL-12	ESTRÍA	200	\$129.72

- Maneral tauro
- Ensamble cuadro o estría
- Acabado cromo



FIGURA	ENSAMBLE	CONT. MTR	PRECIO UNIT.
RL-30	CUADRO	200	\$109.11
RL-31	ESTRÍA	200	\$116.21

MANERALES MONOMANDO

- Para figura
- 23-MTC, 23-MTL, 23-MTS, 24-MTC, 24-MTS, 34-MT



FIGURA	ACABADO	CONT. MASTER	PRECIO UNITARIO
M-23MT	CROMO	100	\$183.76

- Para figuras
- 7-C, 20-MC, 34-MC, 34-MCO



FIGURA	ACABADO	CONT. MASTER	PRECIO UNITARIO
M-34MC	CROMO	100	\$282.16

- Para figura
- 34-MQ



FIGURA	ACABADO	CONT. MASTER	PRECIO UNITARIO
M-34MQ	CROMO	100	\$151.87

- Para figuras
- 37-MM



FIGURA	ACABADO	CONT. MASTER	PRECIO UNITARIO
M-37MM	CROMO	100	\$201.60

- Para figuras
- 23-MQ



FIGURA	ACABADO	CONT. MASTER	PRECIO UNITARIO
MMEC	CROMO	100	\$370.18

- Para figuras
- 23-MM, 24-MTC, 24-MTL, 24-MTS, 37-MPL, 303-RL, 502-RH



FIGURA	ACABADO	CONT. MASTER	PRECIO UNITARIO
MMPLC	CROMO	100	\$348.38

CHAPETONES

- Para figura 36-PF



FIGURA	ACABADO	CONT. MASTER	PRECIO UNITARIO
C-36P	CROMO	50	\$312.77

- Para llave de empotrar universal



FIGURA	ACABADO	CONT. MASTER	PRECIO UNITARIO
CH-98	CROMO	150	\$179.74

Estos precios **NO** incluyen I.V.A.-Esta lista sustituye a las anteriores-Sujetos a cambios sin previo aviso.
La información e imágenes contenidas pueden sufrir cambios sin previo aviso, por motivos de actualización y mejora continua sin responsabilidad alguna por la marca o su publicidad

CHAPETONES

- Material de latón
- Para llave o mezcladoras de empotrar universal

-40%
EXTRA



FIGURA CH-C **ACABADO CHAPA-ORO** **CONT. MASTER 600** **PRECIO UNITARIO \$453.55**

- Material de latón
- Para llave o mezcladoras de empotrar universal

-40%
EXTRA



FIGURA CH-G **ACABADO CHAPA-ORO** **CONT. MASTER 50** **PRECIO UNITARIO \$991.88**

- Material de latón
- Para llave o mezcladoras de empotrar



FIGURA CH-GC **ACABADO CROMO** **CONT. MASTER 50** **PRECIO UNITARIO \$581.90**

- Material de latón
- Para llave o mezcladoras de empotrar



FIGURA CH-GS **ACABADO SATINADO** **CONT. MASTER 50** **PRECIO UNITARIO \$597.98**

- Para llave o mezcladoras de empotrar antiguas



FIGURA RE-07 **ACABADO CROMO** **CONT. MASTER 150** **PRECIO UNITARIO \$174.33**

- Para llave o mezcladoras de empotrar



FIGURA RE-15 **ACABADO CROMO** **CONT. MASTER 150** **PRECIO UNITARIO \$165.31**

REGADERAS

- Medida 1 3/4"Ø (44 mm)
- Presión (baja/media)
- Material de latón
- Sin brazo



FIGURA 44-A **ACABADO CROMO** **CONT. MASTER 100** **PRECIO UNITARIO \$841.60**

- Medida 4"Ø (102 mm)
- Presión (baja/media)
- 5 funciones
- Sin brazo



FIGURA 44-AB **ACABADO CROMO** **CONT. MASTER 50** **PRECIO UNITARIO \$367.01**

- Medida 4"Ø (102 mm)
- Presión (baja/media)
- 5 funciones
- Sin brazo



FIGURA 44-AC **ACABADO CROMO** **CONT. MASTER 50** **PRECIO UNITARIO \$471.66**

- Medida 4 1/2"Ø (115 mm)
- Presión (baja/media)
- 5 funciones
- Sin brazo
- Fácil limpieza



FIGURA 44-AD **ACABADO CROMO** **CONT. MASTER 50** **PRECIO UNITARIO \$375.18**

Estos precios **NO** incluyen I.V.A.-Esta lista sustituye a las anteriores-Sujetos a cambios sin previo aviso.

La información e imágenes contenidas pueden sufrir cambios sin previo aviso, por motivos de actualización y mejora continua sin responsabilidad alguna por la marca o su publicidad

REGADERAS

	<ul style="list-style-type: none"> • Medida 4"Ø (102 mm) • Presión (baja/media) • 5 funciones • Sin brazo • Fácil limpieza 		<ul style="list-style-type: none"> • Medida 3.8"Ø • Presión (baja/media) • 5 funciones • Sin brazo • Fácil limpieza
FIGURA 44-AE	ACABADO CROMO	FIGURA 44-AF	ACABADO CROMO
	<ul style="list-style-type: none"> • Medida 2 1/6"Ø (52 mm) • Presión (baja/media) • Material de latón • Sin brazo 		<ul style="list-style-type: none"> • Medida 6"Ø (152 mm) • Presión (baja/media) • Sin brazo • Fácil limpieza
FIGURA 44-AG	ACABADO CROMO	FIGURA 44-AM	ACABADO CROMO
	<ul style="list-style-type: none"> • Medida 4"Ø (102 mm) • Presión (baja) • Sin brazo • Fácil limpieza 		<ul style="list-style-type: none"> • Medida 3 3/4"Ø (95 mm) • Presión (baja/media) • 4 funciones • Sin brazo
FIGURA 44-AN	ACABADO CROMO	FIGURA 44-AP	ACABADO CROMO
	<ul style="list-style-type: none"> • Medida 3 1/4"Ø (82 mm) • Presión (baja/media) • Sin brazo • Fácil limpieza 		<ul style="list-style-type: none"> • Medida 1 3/4"Ø (44 mm) • Presión (baja/media) • Sin brazo
FIGURA 44-AR	ACABADO CROMO	FIGURA 44-AZ	ACABADO CROMO
	<ul style="list-style-type: none"> • Medida 3"Ø (76 mm) • Presión (baja/media) • 3 funciones • Sin brazo 		<ul style="list-style-type: none"> • Medida 3"Ø (76 mm) • Presión (baja/media) • 5 funciones • Sin brazo
FIGURA 44-BB	ACABADO BLANCO	FIGURA 44-BC	ACABADO CROMO

Estos precios **NO** incluyen I.V.A.-Esta lista sustituye a las anteriores-Sujetos a cambios sin previo aviso.

La información e imágenes contenidas pueden sufrir cambios sin previo aviso, por motivos de actualización y mejora continua sin responsabilidad alguna por la marca o su publicidad

REGADERAS



- Medida 3 7/8"Ø (98 mm)
- Presión (baja/media)
- Material de latón
- Sin brazo



FIGURA 44-CA **ACABADO** CROMO **CONT. MASTER** 50 **PRECIO UNITARIO** \$1,322.51



- Medida 2 3/4"Ø (70 mm)
- Presión (baja/media)
- Sin brazo
- Fácil limpieza



FIGURA 44-CB **ACABADO** BLANCO **CONT. MASTER** 125 **PRECIO UNITARIO** \$101.24



- Medida 2 3/4"Ø (70 mm)
- Presión (baja/media)
- Sin brazo
- Fácil limpieza



FIGURA 44-CC **ACABADO** CROMO **CONT. MASTER** 125 **PRECIO UNITARIO** \$106.70



- Medida 2 3/4"Ø (70 mm)
- Presión (baja/media/alta)
- Con brazo y chapetón
- Con dispositivo ahorrador
- Fácil limpieza



FIGURA 44-CCE **ACABADO** CROMO **CONT. MASTER** 50 **PRECIO UNITARIO** \$237.29



- Medida 3.6"Ø (91.4 mm)
- Presión (baja/media)
- Sin brazo
- Fácil limpieza



FIGURA 44-CM **ACABADO** CROMO **CONT. MASTER** 50 **PRECIO UNITARIO** \$207.77



- Medida 9"Ø (229 mm)
- Presión (baja/media)
- Sin brazo
- Fácil limpieza



FIGURA 44-CP **ACABADO** CROMO **CONT. MASTER** 20 **PRECIO UNITARIO** \$903.49



- Medida 3 3/8"Ø (86 mm)
- Presión (baja/media)
- Con 5 funciones
- Sin brazo



FIGURA 44-CR **ACABADO** CROMO **CONT. MASTER** 60 **PRECIO UNITARIO** \$459.40



- Medida 5"Ø (127 mm)
- Presión (baja/media/alta)
- Con 7 funciones
- Sin brazo



FIGURA 44-CRG **ACABADO** CROMO **CONT. MASTER** 50 **PRECIO UNITARIO** \$687.26



- Ultra delgada
- Acabado espejo brillante
- Presión (baja)
- Acero inoxidable 304
- Sin brazo
- Fácil limpieza



FIGURA 44-DCA **MEDIDA** 6X6" (152mm) **CONT. MASTER** 30 **PRECIO UNITARIO** \$876.40
44-DCB 8X8" (204mm) **CONT. MASTER** 20 **PRECIO UNITARIO** \$1,078.89
44-DCC 10X10" (254mm) **CONT. MASTER** 10 **PRECIO UNITARIO** \$1,417.43



- Ultra delgada
- Medida 4x4" (102x102 mm)
- Presión (baja/media)
- Material acero inoxidable
- Sin brazo
- Fácil limpieza



FIGURA 44-DCP **ACABADO** ESPEJO **CONT. MASTER** 125 **PRECIO UNITARIO** \$327.62

Estos precios **NO** incluyen I.V.A.-Esta lista sustituye a las anteriores-Sujetos a cambios sin previo aviso.

La información e imágenes contenidas pueden sufrir cambios sin previo aviso, por motivos de actualización y mejora continua sin responsabilidad alguna por la marca o su publicidad

REGADERAS

	<ul style="list-style-type: none"> • Ultra delgada • Acabado espejo brillante • Presión (baja) • Acero inoxidable 304 • Sin brazo • Fácil limpieza 			<ul style="list-style-type: none"> • Ultra delgada • Medida 4"Ø (102 mm) • Presión (baja/media) • Material acero inoxidable • Sin brazo • Fácil limpieza 			
FIGURA 44-DRA	MEDIDA 6" Ø (152mm)	CONT. MASTER 30	PRECIO UNITARIO \$870.07	FIGURA 44-DRP	ACABADO ESPEJO	CONT. MASTER 60	PRECIO UNITARIO \$327.62
FIGURA 44-DRB	MEDIDA 8" Ø (204mm)	CONT. MASTER 20	PRECIO UNITARIO \$1,078.89				
FIGURA 44-DRC	MEDIDA 10" Ø (254mm)	CONT. MASTER 10	PRECIO UNITARIO \$1,417.43				
	<ul style="list-style-type: none"> • Medida 2 1/4"Ø (57 mm) • Presión (baja/media) • Con brazo y chapetón 			<ul style="list-style-type: none"> • Medida 2 3/4"Ø (70 mm) • Presión (baja) • Con brazo y chapetón 			
FIGURA 44-F	ACABADO CROMO	CONT. MASTER 50	PRECIO UNITARIO \$272.77	FIGURA 44-G	ACABADO CROMO	CONT. MASTER 50	PRECIO UNITARIO \$375.71
	<ul style="list-style-type: none"> • Medida 8"Ø (204 mm) • Presión (baja/media) • Sin brazo • Fácil limpieza 			<ul style="list-style-type: none"> • Medida 2 3/4"Ø (70 mm) • Presión (baja) • Material de latón • Sin brazo 			
FIGURA 44-GA	ACABADO CROMO	CONT. MASTER 12	PRECIO UNITARIO \$756.55	FIGURA 44-GO	ACABADO CROMO-LATÓN	CONT. MASTER 100	PRECIO UNITARIO \$527.35
	<ul style="list-style-type: none"> • Medida 8x8" (204x204 mm) • Presión (baja/media) • Anti sarro • Sin brazo • Fácil limpieza 			<ul style="list-style-type: none"> • Medida 6x6" (152x152 mm) • Presión (baja/media) • Anti sarro • Sin brazo • Fácil limpieza 			
FIGURA 44-GP	ACABADO CROMO	CONT. MASTER 20	PRECIO UNITARIO \$820.35	FIGURA 44-GS	ACABADO CROMO	CONT. MASTER 20	PRECIO UNITARIO \$532.67
	<ul style="list-style-type: none"> • Medida 6x6" (152x152 mm) • Presión (baja/media) • Anti sarro • Sin brazo • Fácil limpieza 			<ul style="list-style-type: none"> • Medida 5"Ø (127 mm) • Presión (baja/media) • Sin brazo • Fácil limpieza 			
FIGURA 44-GSS	ACABADO SATINADO	CONT. MASTER 20	PRECIO UNITARIO \$635.62	FIGURA 44-H	ACABADO CROMO	CONT. MASTER 50	PRECIO UNITARIO \$274.94

Estos precios **NO** incluyen I.V.A.-Esta lista sustituye a las anteriores-Sujetos a cambios sin previo aviso.

La información e imágenes contenidas pueden sufrir cambios sin previo aviso, por motivos de actualización y mejora continua sin responsabilidad alguna por la marca o su publicidad

REGADERAS

	<ul style="list-style-type: none"> • Medida 8"Ø (204 mm) • Presión (baja/media) • Anti sarro • Sin brazo • Fácil limpieza 		<ul style="list-style-type: none"> • Medida 1 1/2"Ø (38 mm) • Presión (baja/media) • Sin brazo
FIGURA 44-HC	ACABADO CROMO	CONT. MASTER 12	PRECIO UNITARIO \$690.83
	<ul style="list-style-type: none"> • Medida 1 1/2"Ø (38 mm) • Presión (baja/media) • Con brazo y chapetón 		<ul style="list-style-type: none"> • Medida 1 1/2"Ø (38 mm) • Presión (baja/media/alta) • Con brazo y chapetón • Con dispositivo ahorrador
FIGURA 44-IB	ACABADO CROMO	CONT. MASTER 50	PRECIO UNITARIO \$148.07
	<ul style="list-style-type: none"> • Medida 3"Ø (76 mm) • Presión (baja/media) • Material de latón • Sin brazo 		<ul style="list-style-type: none"> • Medida 3"Ø (76 mm) • Presión (baja/media/alta) • Material de latón • Sin brazo
FIGURA 44-IC	ACABADO CROMO	CONT. MASTER 40	PRECIO UNITARIO \$1,506.02
	<ul style="list-style-type: none"> • Medida 3 1/8"Ø (80 mm) • Presión (baja/media) • Con brazo y chapetón 		<ul style="list-style-type: none"> • Medida 7 1/2"X7 1/2" (190x190 mm) • Presión (baja/media/alta) • Sin brazo • Fácil limpieza
FIGURA 44-M	ACABADO CROMO	CONT. MASTER 50	PRECIO UNITARIO \$252.24
	<ul style="list-style-type: none"> • Medida 3 1/8"Ø (80 mm) • Presión (baja/media/alta) • Con brazo y chapetón • Con dispositivo ahorrador 		<ul style="list-style-type: none"> • Medida 3 1/2"Ø (89 mm) • Presión (baja/media) • Con brazo y chapetón
FIGURA 44-ME	ACABADO CROMO	CONT. MASTER 50	PRECIO UNITARIO \$344.88
FIGURA 44-N	ACABADO CROMO	CONT. MASTER 50	PRECIO UNITARIO \$243.67

Estos precios **NO** incluyen I.V.A.-Esta lista sustituye a las anteriores-Sujetos a cambios sin previo aviso.

La información e imágenes contenidas pueden sufrir cambios sin previo aviso, por motivos de actualización y mejora continua sin responsabilidad alguna por la marca o su publicidad

REGADERAS

	<ul style="list-style-type: none"> • Medida 3 3/4"Ø (95 mm) • Presión (baja) • Anti sarro • Sin brazo • Fácil limpieza 	  		<ul style="list-style-type: none"> • Medida 3 1/4"Ø (83 mm) • Presión (baja/media) • Sin brazo • 5 funciones 	 		
FIGURA 44-P	ACABADO CROMO	CONT. MASTER 50	PRECIO UNITARIO \$261.92	FIGURA 44-PC	ACABADO CROMO	CONT. MASTER 60	PRECIO UNITARIO \$769.46
	<ul style="list-style-type: none"> • Medida 5"Ø (127 mm) • Presión (baja/media) • Sin brazo • Fácil limpieza 	  		<ul style="list-style-type: none"> • Medida 4.7"Ø (119 mm) • Presión (baja/media) • Sin brazo 	 		
FIGURA 44-PCC	ACABADO CROMO	CONT. MASTER 50	PRECIO UNITARIO \$284.34	FIGURA 44-PF	ACABADO CROMO	CONT. MASTER 50	PRECIO UNITARIO \$274.63
	<ul style="list-style-type: none"> • Con brazo y chapetón • Presión media • Medida 8"Ø (204 mm) 	 		<ul style="list-style-type: none"> • Sin brazo • Presión media • Medida 8"Ø (204 mm) 	 		
FIGURA 44-PG	ACABADO CROMO	CONT. MASTER 12	PRECIO UNITARIO \$812.71	FIGURA 44-PGS	ACABADO CROMO	CONT. MASTER 12	PRECIO UNITARIO \$755.57
	<ul style="list-style-type: none"> • Anti sarro • Presión baja • Medida 4 1/2"Ø (114 mm) • Sin brazo • Fácil limpieza 	  		<ul style="list-style-type: none"> • Anti sarro • Presión media • Medida 9 7/16"Ø (239 mm) • Sin brazo • Fácil limpieza 	 		
FIGURA 44-PH	ACABADO CROMO	CONT. MASTER 50	PRECIO UNITARIO \$287.12	FIGURA 44-PO	ACABADO CROMO	CONT. MASTER 20	PRECIO UNITARIO \$771.02
	<ul style="list-style-type: none"> • Medida 2 3/4"Ø (70 mm) • Presión (baja) • Con brazo y chapetón 	 		<ul style="list-style-type: none"> • Medida 10X2" (254X50 mm) • Presión (baja/media) • Sin brazo • Fácil limpieza 	 		
FIGURA 44-R	ACABADO CROMO	CONT. MASTER 50	PRECIO UNITARIO \$250.95	FIGURA 44-RC	ACABADO CROMO	CONT. MASTER 50	PRECIO UNITARIO \$341.07

Estos precios **NO** incluyen I.V.A.-Esta lista sustituye a las anteriores-Sujetos a cambios sin previo aviso.

La información e imágenes contenidas pueden sufrir cambios sin previo aviso, por motivos de actualización y mejora continua sin responsabilidad alguna por la marca o su publicidad

REGADERAS

	<ul style="list-style-type: none"> • Medida 4.5"Ø (114 mm) • Presión (baja/media) • Sin brazo 		<ul style="list-style-type: none"> • Medida 3 1/8"Ø (80 mm) • Presión (baja) • Con brazo y chapetón
FIGURA 44-RR	ACABADO CROMO	CONT. MASTER 50	PRECIO UNITARIO \$311.49
	<ul style="list-style-type: none"> • Ultra delgada • Medida 8X8" (204X204 mm) • Presión (baja) • Acero inoxidable 304 • Sin brazo • Fácil limpieza 		<ul style="list-style-type: none"> • Medida 2 1/4"Ø (57 mm) • Presión (baja/media) • Material de latón • Con brazo y chapetón
FIGURA 44-SCB	ACABADO SATINADO	CONT. MASTER 20	PRECIO UNITARIO \$1,106.37
	<ul style="list-style-type: none"> • Ultra delgada • Medida 8"Ø (204X204 mm) • Presión (baja) • Acero inoxidable 304 • Sin brazo • Fácil limpieza 		<ul style="list-style-type: none"> • Medida 2 3/4"Ø (70 mm) • Presión (baja/media) • Anti sarro • Fácil limpieza
FIGURA 44-SRB	ACABADO SATINADO	CONT. MASTER 20	PRECIO UNITARIO \$1,106.39
	<ul style="list-style-type: none"> • Medida 2 3/4"Ø (70 mm) • Presión (baja/media) • 3 funciones • Sin brazo • Fácil limpieza 		<ul style="list-style-type: none"> • Medida 7"Ø (222 mm) • Presión (baja/media) • 3 funciones • Sin brazo • Fácil limpieza
FIGURA 44-TA	ACABADO CROMO	CONT. MASTER 30	PRECIO UNITARIO \$931.05
	<ul style="list-style-type: none"> • Medida 3 1/2"Ø (89 mm) • Presión (baja/media) • 5 funciones • Sin brazo • Fácil limpieza 		<ul style="list-style-type: none"> • Medida 3 1/8"Ø (80 mm) • Presión (baja/media) • 5 funciones • Sin brazo • Fácil limpieza
FIGURA 44-TC	ACABADO CROMO	CONT. MASTER 12	PRECIO UNITARIO \$2,145.78
			PRECIO UNITARIO \$614.64

Estos precios **NO** incluyen I.V.A.-Esta lista sustituye a las anteriores-Sujetos a cambios sin previo aviso.

La información e imágenes contenidas pueden sufrir cambios sin previo aviso, por motivos de actualización y mejora continua sin responsabilidad alguna por la marca o su publicidad

REGADERAS



- Medida 7"Ø (184 mm)
- Presión (baja/media)
- 5 funciones
- Sin brazo
- Fácil limpieza

FIGURA 44-TN **ACABADO** CROMO **CONT. MASTER** 20 **PRECIO UNITARIO** \$1,305.99

REGADERA FACIL LIMPIEZA Grado ecológico **NOM**



- Medida 3 1/4"Ø (83 mm)
- Presión (media)
- 5 funciones
- Sin brazo
- Fácil limpieza

FIGURA 44-TPC **ACABADO** CROMO **CONT. MASTER** 24 **PRECIO UNITARIO** \$2,542.83

REGADERA FACIL LIMPIEZA Grado ecológico **NOM**



- Medida 4"Ø (102 mm)
- Presión (baja/media)
- Con brazo
- Fácil limpieza

FIGURA 44-TRC **ACABADO** CROMO **CONT. MASTER** 24 **PRECIO UNITARIO** \$1,322.51

REGADERA FACIL LIMPIEZA Grado ecológico **NOM**



- Ultra delgada
- Acabado espejo brillante
- Presión (baja)
- Acero inoxidable 201
- Sin brazo
- Fácil limpieza

FIGURA 44-UCA **MEDIDA** 6X6" (152mm) **CONT. MASTER** 30 **PRECIO UNITARIO** \$414.79
 44-UCB 8X8" (204mm) 20 \$534.70
 44-UCC 10X10" (254mm) 10 \$964.99

REGADERA FACIL LIMPIEZA Grado ecológico **NOM**



- Ultra delgada
- Acabado espejo brillante
- Presión (baja)
- Acero inoxidable
- Sin brazo
- Fácil limpieza

FIGURA 44-URA **MEDIDA** 6" Ø (152mm) **CONT. MASTER** 30 **PRECIO UNITARIO** \$414.79
 44-URB 8" Ø (204mm) 20 \$544.19
 44-URC 10" Ø (254mm) 10 \$964.99

REGADERA FACIL LIMPIEZA Grado ecológico **NOM**



- Medida 1"Ø (25 mm)
- Presión (baja/media)
- Material de latón
- Sin brazo
- Con botón de control

FIGURA 44-V **ACABADO** CROMO **CONT. MASTER** 200 **PRECIO UNITARIO** \$459.87

Grado ecológico **NOM**



- Medida 1"Ø (25 mm)
- Presión (baja/media)
- Material de latón
- Sin brazo

FIGURA 44-VS **ACABADO** CROMO **CONT. MTR** 200 **PRECIO UNIT.** \$348.66

Grado ecológico **NOM**



- Medida 6"Ø (152 mm)
- Presión (baja)
- Con brazo y chapetón
- Fácil limpieza

FIGURA 44-WG **ACABADO** CROMO **CONT. MTR** 12 **PRECIO UNIT.** \$654.64

REGADERA FACIL LIMPIEZA Grado ecológico **NOM**



- Medida 6"Ø (152 mm)
- Presión (baja)
- Sin brazo
- Fácil limpieza

FIGURA 44-WGS **ACABADO** CROMO **CONT. MTR** 12 **PRECIO UNIT.** \$608.50

REGADERA FACIL LIMPIEZA Grado ecológico **NOM**

BRAZOS REGADERAS



- Material de latón
- Longitud de 15 cm
- Chapetón de acero inoxidable

FIGURA 45 **ACABADO** CROMO **CONT. MASTER** 100 **PRECIO UNITARIO** \$281.59



- Material de acero
- Longitud de 15 cm
- Chapetón de acero inoxidable

FIGURA 45-B **ACABADO** CROMO **CONT. MASTER** 100 **PRECIO UNITARIO** \$63.72

Estos precios **NO** incluyen I.V.A.-Esta lista sustituye a las anteriores-Sujetos a cambios sin previo aviso.

La información e imágenes contenidas pueden sufrir cambios sin previo aviso, por motivos de actualización y mejora continua sin responsabilidad alguna por la marca o su publicidad

BRAZOS REGADERAS

- Material de acero inoxidable
- Longitud de 39 cm
- Chapetón de acero inoxidable



FIGURA 45-BA **ACABADO CROMO** **CONT. MASTER 50** **PRECIO UNITARIO \$287.31**

- Material de acero inoxidable
- Longitud de 15 cm
- Chapetón de acero inoxidable



FIGURA 45-BAI **ACABADO CROMO** **CONT. MASTER 100** **PRECIO UNITARIO \$120.23**

- Material de acero
- Longitud de 26 cm
- Chapetón de acero inoxidable



FIGURA 45-BC **ACABADO CROMO** **CONT. MASTER 50** **PRECIO UNITARIO \$105.20**

- Material de acero inoxidable
- Longitud 50 cm (extra largo)
- Chapetón de acero inoxidable



FIGURA 45-BEA **ACABADO CROMO** **CONT. MASTER 40** **PRECIO UNITARIO \$658.09**

- Material de acero
- Longitud de 39 cm
- Chapetón de acero inoxidable



FIGURA 45-BF **ACABADO CROMO** **CONT. MASTER 30** **PRECIO UNITARIO \$195.37**

- Material de latón
- Longitud de 39 cm
- Chapetón de acero inoxidable



FIGURA 45-BL **ACABADO CROMO** **CONT. MASTER 20** **PRECIO UNITARIO \$526.00**



- Material de latón
- Longitud de 39 cm
- Chapetón de acero inoxidable



FIGURA 45-BR **ACABADO CROMO** **CONT. MASTER 20** **PRECIO UNITARIO \$503.06**



- Material de acero inoxidable
- Longitud de 39 cm
- Chapetón de acero inoxidable



FIGURA 45-BRA **ACABADO CROMO** **CONT. MASTER 50** **PRECIO UNITARIO \$274.94**

- Material de acero
- Longitud de 39 cm
- Chapetón de acero inoxidable



FIGURA 45-BRF **ACABADO CROMO** **CONT. MASTER 20** **PRECIO UNITARIO \$165.31**

- Material de acero inoxidable
- Longitud 39 cm
- Chapetón de acero inoxidable



FIGURA 45-BRS **ACABADO SATINADO** **CONT. MASTER 20** **PRECIO UNITARIO \$392.32**

Estos precios **NO** incluyen I.V.A.-Esta lista sustituye a las anteriores-Sujetos a cambios sin previo aviso.

La información e imágenes contenidas pueden sufrir cambios sin previo aviso, por motivos de actualización y mejora continua sin responsabilidad alguna por la marca o su publicidad







BRAZOS REGADERAS

		<ul style="list-style-type: none"> Material de acero Longitud de 21 cm Chapetón de acero inoxidable 							
									
FIGURA 45-CF	ACABADO CROMO	CONT. MASTER 50	PRECIO UNITARIO \$104.41		ACABADO CROMO	CONT. MASTER 40	PRECIO UNITARIO \$680.24	<ul style="list-style-type: none"> Material de acero inoxidable Longitud de 30 cm Flexible Chapetón de acero inoxidable 	
		<ul style="list-style-type: none"> Material de latón Longitud de 21 cm Contemporaneo 	-40% EXTRA						
								<ul style="list-style-type: none"> Material de latón Longitud de 15 cm Chapetón de latón 	-40% EXTRA
FIGURA 45-I	ACABADO CROMO	CONT. MASTER 40	PRECIO UNITARIO \$1,077.32	FIGURA 45-LB	ACABADO LATÓN-BLANCO	CONT. MASTER 100	PRECIO UNITARIO \$424.67		
		<ul style="list-style-type: none"> Material A.B.S. Longitud de 15 cm Chapetón A.B.S. 							
								<ul style="list-style-type: none"> Material de acero Longitud 35 cm Chapetón de acero inoxidable 	
FIGURA 45-PC	ACABADO CROMO	CONT. MASTER 200	PRECIO UNITARIO \$53.80	FIGURA 45-R	ACABADO CROMO	CONT. MASTER 40	PRECIO UNITARIO \$188.40		

OBTURADOR REGADERA

		<ul style="list-style-type: none"> Material de latón 							
									
FIGURA RFR-01	ACABADO CROMO	CONT. MASTER 50	PRECIO UNITARIO \$174.33					-40% EXTRA	

RESUMIDEROS

		<ul style="list-style-type: none"> Material de latón Medida 100x100 mm 							
									
FIGURA 46	ACABADO CROMO	CONT. MTR 60	PRECIO UNIT. \$589.12	FIGURA 46	ACABADO CROMO	CONT. MTR 40	PRECIO UNIT. \$1,002.96	<ul style="list-style-type: none"> Anti cucarachas Medida 100x100 mm 	
									
									
FIGURA 46	ACABADO CROMO	CONT. MTR 100	PRECIO UNIT. \$272.10	FIGURA 46-AF	ACABADO CROMO	CONT. MTR 100	PRECIO UNIT. \$272.10		

Estos precios **NO** incluyen I.V.A.-Esta lista sustituye a las anteriores-Sujetos a cambios sin previo aviso.

La información e imágenes contenidas pueden sufrir cambios sin previo aviso, por motivos de actualización y mejora continua sin responsabilidad alguna por la marca o su publicidad

RESUMIDEROS

- Acero inoxidable
- Anti cucarachas
- Medida 100x100 mm



FIGURA ACABADO CONT. MTR PRECIO UNIT.
46-AI PULIDO 100 \$282.54

- Acero inoxidable
- Anti cucarachas
- Medida 150x150 mm



FIGURA ACABADO CONT. MTR PRECIO UNIT.
46-AIC PULIDO 60 \$601.14

- Anti cucarachas
- Medida 150x150 mm



FIGURA ACABADO CONT. MTR PRECIO UNIT.
46-AR CROMO 60 \$556.15

- Anti cucarachas
- De push
- Medida 100x100 mm



FIGURA ACABADO CONT. MTR PRECIO UNIT.
46-P CROMO 100 \$397.54

- Medida 100x100 mm



FIGURA ACABADO CONT. MTR PRECIO UNIT.
46-Z CROMO 100 \$181.83

- Material de bronce
- Anti cucarachas
- Ensamble a P.V.C. 2"
- Medida 100 Ø



FIGURA ACABADO CONT. MTR PRECIO UNIT.
47-C CROMO 50 \$411.31

- Anti cucarachas
- Ensamble a P.V.C. 2"
- Medida 100 Ø



FIGURA ACABADO CONT. MTR PRECIO UNIT.
47-CZ CROMO 100 \$156.55

- Anti cucarachas
- De push
- Medida 100 Ø



FIGURA ACABADO CONT. MTR PRECIO UNIT.
47-P CROMO 100 \$356.45

- **PRESENTACIÓN EN BOLSA**
- Material de polipropileno
- Para tubo de 2" a 4"
- Con rejilla cromada
- Medida 150 mm Ø



FIGURA CONT. MTR PRECIO UNIT.
47-PRB 60 \$77.52

- Material de polipropileno
- Para tubo de 2" a 4"
- Con rejilla cromada
- Medida 150 Ø



FIGURA CONT. MTR
47-PRC 60

PRECIO UNIT.
\$82.58

- Material de acero inoxidable
- Anti cucarachas
- Ensamble a P.V.C. 4"
- Medida 150x150 mm



**-40%
EXTRA**



FIGURA ACABADO CONT. MTR PRECIO UNIT.
151-B CROMO 50 \$1,110.22

CANALETA Y REJILLAS

- Medida de 1 metro
- Material polipropileno negro



FIGURA CONT. MASTER
48-CHP 72



PRECIO UNITARIO
\$963.48

- Material polietileno negro
- Con 4 salidas



FIGURA CONT. MASTER
48-EHP 10



PRECIO UNITARIO
\$1,567.51

Estos precios **NO** incluyen I.V.A.-Esta lista sustituye a las anteriores-Sujetos a cambios sin previo aviso.

La información e imágenes contenidas pueden sufrir cambios sin previo aviso, por motivos de actualización y mejora continua sin responsabilidad alguna por la marca o su publicidad

- Medida de 1 metro
- Material acero galvanizado



FIGURA 48-RHA

CONT. MASTER 5



PRECIO UNITARIO \$766.01

- Medida de 1 metro
- Material polietileno



FIGURA 48-RHP

CONT. MASTER 5



PRECIO UNITARIO \$703.10

- Material polietileno negro
- Con rejilla brickslot negro de .5 metro



FIGURA 48-RHR

CONT. MASTER 5



PRECIO UNITARIO \$607.61

- Material polietileno negro
- Kit para instalación



FIGURA 48-KAH

CONT. MASTER 30



PRECIO UNITARIO \$781.24

- Material polietileno negro



FIGURA 48-TSH

CONT. MASTER 10



PRECIO UNITARIO \$750.88



Estos precios **NO** incluyen I.V.A.-Esta lista sustituye a las anteriores-Sujetos a cambios sin previo aviso.

La información e imágenes contenidas pueden sufrir cambios sin previo aviso, por motivos de actualización y mejora continua sin responsabilidad alguna por la marca o su publicidad

LÍNEA CLÁSICA

PAPELERA

- Para empotrar



FIGURA JE-107	ACABADO CROMO	CONT. MASTER 20	PRECIO UNITARIO \$775.16
-------------------------	-------------------------	---------------------------	------------------------------------

PORTA ROLLO

- De semi empotrar



FIGURA JE-108	ACABADO CROMO	CONT. MASTER 50	PRECIO UNITARIO \$321.61
-------------------------	-------------------------	---------------------------	------------------------------------

CEPILLERO

- De semi empotrar



FIGURA JE-220	ACABADO CROMO	CONT. MASTER 100	PRECIO UNITARIO \$230.45
-------------------------	-------------------------	----------------------------	------------------------------------

TOALLERO DE ARGOLLA

- De semi empotrar



FIGURA JE-260	ACABADO CROMO	CONT. MASTER 60	PRECIO UNITARIO \$273.52
-------------------------	-------------------------	---------------------------	------------------------------------

JABONERA

- De semi empotrar



FIGURA JE-303	ACABADO CROMO	CONT. MASTER 100	PRECIO UNITARIO \$225.74
-------------------------	-------------------------	----------------------------	------------------------------------

JABONERA

- De semi empotrar
- Con agarradera



FIGURA JE-306	ACABADO CROMO	CONT. MASTER 20	PRECIO UNITARIO \$841.60
-------------------------	-------------------------	---------------------------	------------------------------------

GANCHO DOBLE

- De semi empotrar



FIGURA JE-502	ACABADO CROMO	CONT. MASTER 100	PRECIO UNITARIO \$141.84
-------------------------	-------------------------	----------------------------	------------------------------------

TOALLERO BARRA

- De semi empotrar
- Medida de 24" (610 mm)



FIGURA JE-606	ACABADO CROMO	CONT. MASTER 20	PRECIO UNITARIO \$597.98
-------------------------	-------------------------	---------------------------	------------------------------------

PORTA ROLLO

- De A.B.S.



FIGURA PRP	CONT. MASTER 500	PRECIO UNITARIO \$15.66
----------------------	----------------------------	-----------------------------------

Estos precios **NO** incluyen I.V.A.-Esta lista sustituye a las anteriores-Sujetos a cambios sin previo aviso.
La información e imágenes contenidas pueden sufrir cambios sin previo aviso, por motivos de actualización y mejora continua sin responsabilidad alguna por la marca o su publicidad

LÍNEA BERLÍN

GANCHO SENCILLO

- De semi empotrar



FIGURA GA-700	ACABADO CROMO	CONT. MASTER 40	PRECIO UNITARIO \$408.14
------------------	------------------	--------------------	-----------------------------

JABONERA

- De semi empotrar
- Canastilla de acero inoxidable



FIGURA JE-700	ACABADO CROMO	CONT. MASTER 100	PRECIO UNITARIO \$925.76
------------------	------------------	---------------------	-----------------------------

PORTA ROLLO

- De semi empotrar



FIGURA PR-700	ACABADO CROMO	CONT. MASTER 40	PRECIO UNITARIO \$441.09
------------------	------------------	--------------------	-----------------------------

PORTA VASO

- De semi empotrar



FIGURA PV-700	ACABADO CROMO	CONT. MASTER 40	PRECIO UNITARIO \$408.14
------------------	------------------	--------------------	-----------------------------

TOALLERO ARGOLLA

- De semi empotrar



FIGURA TA-700	ACABADO CROMO	CONT. MASTER 20	PRECIO UNITARIO \$427.13
------------------	------------------	--------------------	-----------------------------

TOALLERO BARRA

- De semi empotrar
- Medida de 24" (610 mm)



FIGURA TB-700	ACABADO CROMO	CONT. MASTER 20	PRECIO UNITARIO \$796.51
------------------	------------------	--------------------	-----------------------------

LÍNEA GRECIA

GANCHO DOBLE

- De semi empotrar



FIGURA GA-96C	ACABADO CROMO	CONT. MASTER 100	PRECIO UNITARIO \$439.78
------------------	------------------	---------------------	-----------------------------

PORTA ROLLO

- De semi empotrar



FIGURA PR-96C	ACABADO CROMO	CONT. MASTER 50	PRECIO UNITARIO \$421.12
------------------	------------------	--------------------	-----------------------------

TOALLERO BARRA

- De semi empotrar
- Medida de 24" (610 mm)



FIGURA TB-96C	ACABADO CROMO	CONT. MASTER 40	PRECIO UNITARIO \$818.30
------------------	------------------	--------------------	-----------------------------

TOALLERO ARGOLLA

- De semi empotrar



FIGURA TG-96C	ACABADO CROMO	CONT. MASTER 40	PRECIO UNITARIO \$632.46
------------------	------------------	--------------------	-----------------------------

Estos precios **NO** incluyen I.V.A.-Esta lista sustituye a las anteriores-Sujetos a cambios sin previo aviso.

La información e imágenes contenidas pueden sufrir cambios sin previo aviso, por motivos de actualización y mejora continua sin responsabilidad alguna por la marca o su publicidad

ACCESORIOS INDIVIDUALES

LÍNEA RUMANIA

	GANCHO SENCILLO • De semi empotrar	-40% EXTRA	FIGURA E322B	ACABADO ORO-BLANCO	CONT. MASTER 20	PRECIO UNITARIO \$545.03		GANCHO SENCILLO • De semi empotrar	-40% EXTRA	FIGURA E322C	ACABADO ORO-CROMO	CONT. MASTER 20	PRECIO UNITARIO \$459.40
	GANCHO • De semi empotrar	-40% EXTRA	FIGURA E322N	ACABADO ORO-NEGRO	CONT. MASTER 20	PRECIO UNITARIO \$564.67		TOALLERO BARRA • De semi empotrar	-40% EXTRA	FIGURA E324B	ACABADO ORO-BLANCO	CONT. MASTER 20	PRECIO UNITARIO \$1,743.12
	TOALLERO BARRA • De semi empotrar	-40% EXTRA	FIGURA E324N	ACABADO ORO-NEGRO	CONT. MASTER 20	PRECIO UNITARIO \$1,831.51		PORTA ROLLO • De semi empotrar	-40% EXTRA	FIGURA E325B	ACABADO ORO-BLANCO	CONT. MASTER 25	PRECIO UNITARIO \$1,743.12
	PAPELERA • De semi empotrar	-40% EXTRA	FIGURA E325N	ACABADO ORO-NEGRO	CONT. MASTER 20	PRECIO UNITARIO \$1,198.07		CEPILLERO • De semi empotrar	-40% EXTRA	FIGURA E328B	ACABADO ORO-BLANCO	CONT. MASTER 60	PRECIO UNITARIO \$667.78
	CEPILLERO • De semi empotrar	-40% EXTRA	FIGURA E328C	ACABADO ORO-CROMO	CONT. MASTER 20	PRECIO UNITARIO \$702.16		CEPILLERO • De semi empotrar	-40% EXTRA	FIGURA E328N	ACABADO ORO-NEGRO	CONT. MASTER 20	PRECIO UNITARIO \$667.78

Estos precios **NO** incluyen I.V.A.-Esta lista sustituye a las anteriores-Sujetos a cambios sin previo aviso.

La información e imágenes contenidas pueden sufrir cambios sin previo aviso, por motivos de actualización y mejora continua sin responsabilidad alguna por la marca o su publicidad

LÍNEA RUMANIA



JABONERA
• De semi empotrar

-40%
EXTRA



JABONERA
• De semi empotrar

-40%
EXTRA

FIGURA	ACABADO	CONT. MASTER	PRECIO UNITARIO	FIGURA	ACABADO	CONT. MASTER	PRECIO UNITARIO
E329B	ORO-BLANCO	20	\$932.93	E329N	ORO-NEGRO	20	\$952.56



TOALLERO ARGOLLA
• De semi empotrar

-40%
EXTRA



TOALLERO ARGOLLA
• De semi empotrar

-40%
EXTRA

FIGURA	ACABADO	CONT. MASTER	PRECIO UNITARIO	FIGURA	ACABADO	CONT. MASTER	PRECIO UNITARIO
E360B	ORO-BLANCO	20	\$775.81	E360N	ORO-NEGRO	20	\$952.56

LÍNEA CORINTO



TOALLERO ARGOLLA
• De semi empotrar

-40%
EXTRA

FIGURA	ACABADO	CONT. MASTER	PRECIO UNITARIO
P-126	ORO-CROMO	20	\$648.60

LÍNEA ESLOVAQUIA



GANCHO SENCILLO
• De semi empotrar



TOALLERO
• De semi empotrar

FIGURA	ACABADO	CONT. MASTER	PRECIO UNITARIO	FIGURA	ACABADO	CONT. MASTER	PRECIO UNITARIO
GA-94C	CROMO	100	\$164.52	PR-94C	CROMO	20	\$281.59



TOALLERO DE ARGOLLA
• De semi empotrar



TOALLERO DE BARRA
• De semi empotrar

FIGURA	ACABADO	CONT. MASTER	PRECIO UNITARIO	FIGURA	ACABADO	CONT. MASTER	PRECIO UNITARIO
TA-94C	CROMO	20	\$240.04	TB-94C	CROMO	20	\$578.27

Estos precios **NO** incluyen I.V.A.-Esta lista sustituye a las anteriores-Sujetos a cambios sin previo aviso.
La información e imágenes contenidas pueden sufrir cambios sin previo aviso, por motivos de actualización y mejora continua sin responsabilidad alguna por la marca o su publicidad

LÍNEA ABA

GANCHO DOBLE

- De semi empotrar
- De acero inoxidable



FIGURA
GD-ABA

CONT. MASTER
300

PRECIO UNITARIO
\$77.61

JABONERA

- De semi empotrar
- De acero inoxidable



FIGURA
JA-BA

ACABADO
CROMO

CONT. MASTER
100

PRECIO UNITARIO
\$73.64

PORTA ROLLO

- De semi empotrar
- De acero inoxidable
- Tubo de A.B.S.



FIGURA
PRA-BA

ACABADO
CROMO

CONT. MASTER
100

PRECIO UNITARIO
\$131.62

TOALLERO BARRA

- De semi empotrar
- De acero inoxidable



FIGURA
TB-ABA

ACABADO
CROMO

CONT. MASTER
50

PRECIO UNITARIO
\$237.29

LÍNEA VERSALLES

JABONERA

- De semi empotrar



FIGURA
JE-304

ACABADO
CROMO

CONT. MASTER
20

PRECIO UNITARIO
\$534.70

DISPENSADOR DE JABÓN

- De semi empotrar



FIGURA
JE-305

ACABADO
CROMO

CONT. MASTER
100

PRECIO UNITARIO
\$544.03

COMPLEMENTOS

GANCHO MÚLTIPLE

- De semi empotrar
- De acero inoxidable
- Medidas: 35.5 x 7 x 5 cm



FIGURA
GM-01

ACABADO
CROMO

CONT. MASTER
40

PRECIO UNITARIO
\$616.96

REPISA DOBLE

- De semi empotrar
- De acero inoxidable
- Esquinera
- Medidas: 40.5 x 15.5 x 25 cm



FIGURA
JE-300

ACABADO
CROMO

CONT. MASTER
10

PRECIO UNITARIO
\$1,490.83

REPISA ESQUINERA

- De semi empotrar
- De acero inoxidable
- Esquinera



FIGURA
JE-301

ACABADO
CROMO

CONT. MASTER
20

PRECIO UNITARIO
\$987.14

VASO PARA CEPILLERO

- Para accesorios de empotrar



FIGURA
RI-47

ACABADO
VIDRIO

CONT. MASTER
20

PRECIO UNITARIO
\$39.49

Estos precios **NO** incluyen I.V.A.-Esta lista sustituye a las anteriores-Sujetos a cambios sin previo aviso.

La información e imágenes contenidas pueden sufrir cambios sin previo aviso, por motivos de actualización y mejora continua sin responsabilidad alguna por la marca o su publicidad

COMPLEMENTOS

JABONERA

- Para accesorios de empotrar



FIGURA RI-48 ACABADO VIDRIO CONT. MASTER 20 PRECIO UNITARIO \$60.37

TOALLERO MÚLTIPLE

- De semi empotrar
- De acero inoxidable
- Medidas: 62.5 x 24 x 21 cm



FIGURA TM-001 ACABADO CROMO CONT. MASTER 10 PRECIO UNITARIO \$1,958.46

BARRAS DE SEGURIDAD

- De semi empotrar
- De acero inoxidable
- 18" de longitud



FIGURA BS-18 ACABADO CROMO CONT. MASTER 20 PRECIO UNITARIO \$901.71

- De semi empotrar
- De acero inoxidable
- 24" de longitud



FIGURA BS-24 ACABADO CROMO CONT. MASTER 20 PRECIO UNITARIO \$1,097.88



- De semi empotrar
- De acero inoxidable
- Con jabonera angular
- 17 1/4" de longitud

FIGURA BSA-01 ACABADO CROMO CONT. MASTER 16 PRECIO UNITARIO \$1,304.48

LAVABOS DE CRISTAL

- Medidas: 60 x 61 cm
- Sin soporte

-40%
EXTRA



FIGURA LAV-12 ACABADO TRANSPARENTE CONT. MASTER 1 PRECIO UNITARIO \$20,675.18

- Medidas: 60 x 61 cm
- Sin soporte

-40%
EXTRA



FIGURA LAV-13 ACABADO SATINADO CONT. MASTER 1 PRECIO UNITARIO \$20,675.18

Estos precios **NO** incluyen I.V.A.-Esta lista sustituye a las anteriores-Sujetos a cambios sin previo aviso.
La información e imágenes contenidas pueden sufrir cambios sin previo aviso, por motivos de actualización y mejora continua sin responsabilidad alguna por la marca o su publicidad

JUEGO DE ACCESORIOS



- De semi empotrar
- En blister
- Gancho doble | Cepillero | Jabonera
- Porta rollo | Toallero de barra

FIGURA A-BA **ACABADO** CROMO **CONT. MASTER** 20 **PRECIO UNITARIO** \$543.70

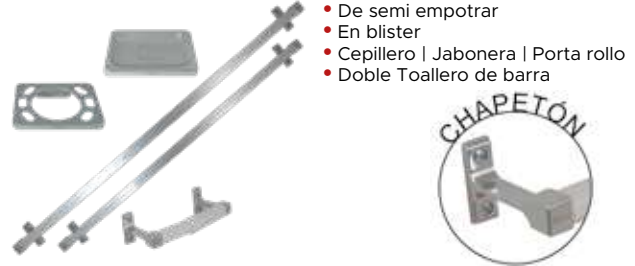

- De semi empotrar
- En blister
- Cepillero | Jabonera | Porta rollo
- Doble Toallero de barra

FIGURA A-BB **ACABADO** CROMO **CONT. MASTER** 20 **PRECIO UNITARIO** \$787.50

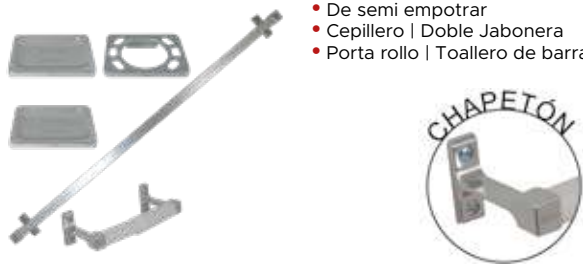

- De semi empotrar
- Cepillero | Doble Jabonera
- Porta rollo | Toallero de barra

FIGURA A-BC **ACABADO** CROMO **CONT. MASTER** 20 **PRECIO UNITARIO** \$868.65



- De semi empotrar

FIGURA J-23CC **ACABADO** CROMO **CONT. MASTER** 4 **PRECIO UNITARIO** \$2,392.55



- De semi empotrar

FIGURA J32-CC **ACABADO** CROMO **CONT. MASTER** 4 **PRECIO UNITARIO** \$2,236.70



- De semi empotrar

FIGURA J50-CC **ACABADO** CROMO **CONT. MASTER** 4 **PRECIO UNITARIO** \$2,191.16



- De semi empotrar

FIGURA JE-02C **ACABADO** CROMO **CONT. MASTER** 4 **PRECIO UNITARIO** \$1,139.16



- De semi empotrar

FIGURA JE-03C **ACABADO** CROMO **CONT. MASTER** 4 **PRECIO UNITARIO** \$1,588.76



- De semi empotrar

FIGURA JE-04C **ACABADO** CROMO **CONT. MASTER** 4 **PRECIO UNITARIO** \$1,312.58



- De semi empotrar

FIGURA JE-05C **ACABADO** CROMO **CONT. MASTER** 4 **PRECIO UNITARIO** \$1,277.43

Estos precios **NO** incluyen I.V.A.-Esta lista sustituye a las anteriores-Sujetos a cambios sin previo aviso.

La información e imágenes contenidas pueden sufrir cambios sin previo aviso, por motivos de actualización y mejora continua sin responsabilidad alguna por la marca o su publicidad

JUEGO DE ACCESORIOS

	• De semi empotrar				• De semi empotrar		
FIGURA JE-120	ACABADO LATÓN-CROMO	CONT. MASTER 4	PRECIO UNITARIO \$2,329.43	FIGURA JE-12C	ACABADO CROMO	CONT. MASTER 4	PRECIO UNITARIO \$2,161.11
	• De semi empotrar				• De semi empotrar		
FIGURA JE-14C	ACABADO CROMO	CONT. MASTER 4	PRECIO UNITARIO \$1,980.31	FIGURA JE-20C	ACABADO CROMO	CONT. MASTER 4	PRECIO UNITARIO \$2,113.01
	• De semi empotrar				• De semi empotrar		
FIGURA JE-20S	ACABADO SATINADO	CONT. MASTER 4	PRECIO UNITARIO \$2,131.05	FIGURA JE-23C	ACABADO LATÓN-CROMO	CONT. MASTER 4	PRECIO UNITARIO \$2,506.76
	• De semi empotrar				• De semi empotrar		
FIGURA JE-23S	ACABADO SATINADO	CONT. MASTER 4	PRECIO UNITARIO \$2,714.63	FIGURA JE-33C	ACABADO CROMO	CONT. MASTER 4	PRECIO UNITARIO \$1,566.13
	• De semi empotrar				• De semi empotrar		
FIGURA JE-910	ACABADO LATÓN-CROMO	CONT. MASTER 4	PRECIO UNITARIO \$2,398.56	FIGURA JE-91C	ACABADO CROMO	CONT. MASTER 4	PRECIO UNITARIO \$1,716.26

Estos precios **NO** incluyen I.V.A.-Esta lista sustituye a las anteriores-Sujetos a cambios sin previo aviso.

La información e imágenes contenidas pueden sufrir cambios sin previo aviso, por motivos de actualización y mejora continua sin responsabilidad alguna por la marca o su publicidad

JUEGO DE ACCESORIOS

 <p>• De semi empotrar</p>		<p>FIGURA JE-94C</p> <p>ACABADO CROMO</p> <p>CONT. MASTER 4</p> <p>PRECIO UNITARIO \$1,815.45</p>	 <p>• De semi empotrar</p>		<p>FIGURA JE-95C</p> <p>ACABADO CROMO</p> <p>CONT. MASTER 4</p> <p>PRECIO UNITARIO \$2,470.69</p>
 <p>• De semi empotrar</p>		<p>FIGURA JE32-C</p> <p>ACABADO LATÓN-CROMO</p> <p>CONT. MASTER 4</p> <p>PRECIO UNITARIO \$2,822.36</p>	 <p>• De semi empotrar</p>		<p>FIGURA JE32-S</p> <p>ACABADO SATINADO</p> <p>CONT. MASTER 4</p> <p>PRECIO UNITARIO \$2,989.89</p>
 <p>• De semi empotrar</p>		<p>FIGURA JE50-C</p> <p>ACABADO LATÓN-CROMO</p> <p>CONT. MASTER 4</p> <p>PRECIO UNITARIO \$2,774.75</p>	 <p>• De semi empotrar</p>		<p>FIGURA JE90-C</p> <p>ACABADO CROMO</p> <p>CONT. MASTER 4</p> <p>PRECIO UNITARIO \$1,887.56</p>
 <p>• De semi empotrar</p>		<p>FIGURA JE95-S</p> <p>ACABADO SATINADO</p> <p>CONT. MASTER 4</p> <p>PRECIO UNITARIO \$2,664.01</p>	 <p>• De semi empotrar</p>		<p>FIGURA JE96-C</p> <p>ACABADO CROMO</p> <p>CONT. MASTER 4</p> <p>PRECIO UNITARIO \$2,760.41</p>
 <p>• De semi empotrar</p>		<p>FIGURA JE96-S</p> <p>ACABADO SATINADO</p> <p>CONT. MASTER 4</p> <p>PRECIO UNITARIO \$2,936.10</p>	 <p>• De semi empotrar</p>		<p>FIGURA JE97-C</p> <p>ACABADO CROMO</p> <p>CONT. MASTER 4</p> <p>PRECIO UNITARIO \$2,322.31</p>

Estos precios **NO** incluyen I.V.A.-Esta lista sustituye a las anteriores-Sujetos a cambios sin previo aviso.

La información e imágenes contenidas pueden sufrir cambios sin previo aviso, por motivos de actualización y mejora continua sin responsabilidad alguna por la marca o su publicidad

JUEGO DE ACCESORIOS



- De semi empotrar



FIGURA
JE97-S **ACABADO**
SATINADO

CONT. MASTER
4

PRECIO UNITARIO
\$2,398.56



- De semi empotrar



FIGURA
JE98-C **ACABADO**
CROMO

CONT. MASTER
4

PRECIO UNITARIO
\$1,578.79



- De semi empotrar



FIGURA
JE99-C **ACABADO**
CROMO

CONT. MASTER
4

PRECIO UNITARIO
\$1,449.07

SALIDAS Y DESAGÜES PARA TINA



- De P.V.C.
- Cierre con botón
- Desagüe automático para tina

FIGURA
21-IP

CONT. MASTER
40

PRECIO UNITARIO
\$487.35



- De P.V.C.
- Cierre a presión
- Desagüe automático para tina

FIGURA
22-IP

CONT. MASTER
20

PRECIO UNITARIO
\$570.42



- Con botón
- A la pared
- Salida para tina

FIGURA
STB **ACABADO**
CROMO

CONT. MASTER
50

PRECIO UNITARIO
\$531.54



- Sin botón
- A la pared
- Salida para tina

FIGURA
STS **ACABADO**
CROMO

CONT. MASTER
50

PRECIO UNITARIO
\$490.41

Estos precios **NO** incluyen I.V.A.-Esta lista sustituye a las anteriores-Sujetos a cambios sin previo aviso.
La información e imágenes contenidas pueden sufrir cambios sin previo aviso, por motivos de actualización y mejora continua sin responsabilidad alguna por la marca o su publicidad

LLAVES MINGITORIO



- Llave para mingitorio
- Conexión hembra
- Cierre compresión
- Medida 13 mm



FIGURA 69 **ACABADO** CROMO **CONT. MASTER** 50 **PRECIO UNITARIO** \$620.13



- Llave para mingitorio
- Conexión hembra-hembra
- Resorte
- Medida 13x13 mm

FIGURA 69-R **ACABADO** CROMO **CONT. MASTER** 48 **PRECIO UNITARIO** \$1,190.26



- Temporizador para mingitorio
- Conexión macho
- Medida 13 mm



FIGURA 69-T **ACABADO** CROMO **CONT. MASTER** 10 **PRECIO UNITARIO** \$3,739.10

LLAVES DE CONTROL



- Angular roscable
- Material de latón
- Cierre de compresión
- Medida 13x13 mm



FIGURA 25 **ACABADO** SATINADO **CONT. MASTER** 200 **PRECIO UNITARIO** \$105.67



- Angular roscable
- Material de latón
- Cierre de compresión
- Medida 13x13 mm



FIGURA 25-CC **ACABADO** SATINADO **CONT. MASTER** 200 **PRECIO UNITARIO** \$109.09



- Angular roscable
- Material de latón
- Cierre a 90°
- Medida 13x13 mm



FIGURA 25-E **ACABADO** SATINADO **CONT. MASTER** 200 **PRECIO UNITARIO** \$78.12



- Angular roscable
- Material de latón
- Cierre de compresión
- Medida 13x13 mm



FIGURA 25-I **ACABADO** CROMO **CONT. MASTER** 200 **PRECIO UNITARIO** \$140.25



- Angular roscable
- Material de latón
- Cierre de compresión
- Medida 13x10 mm



FIGURA 25-IA **ACABADO** SATINADO **CONT. MTR** 200 **PRECIO UNIT.** \$120.71



- Angular P/tubo de cobre
- Material de latón
- Cierre de compresión
- Medida 13x13 mm



FIGURA 25-IC **ACABADO** CROMO **CONT. MTR** 200 **PRECIO UNIT.** \$126.08



- Angular P/tubo de cobre
- Material de latón
- Cierre a 90°
- Medida 13x13 mm



FIGURA 25-ICE **ACABADO** CROMO **CONT. MTR** 200 **PRECIO UNIT.** \$105.67

Estos precios **NO** incluyen I.V.A.-Esta lista sustituye a las anteriores-Sujetos a cambios sin previo aviso.

La información e imágenes contenidas pueden sufrir cambios sin previo aviso, por motivos de actualización y mejora continua sin responsabilidad alguna por la marca o su publicidad

LLAVES DE CONTROL



- Angular roscable
- Material de latón
- Cierre compresión
- Medida 13x13 mm



- Acabado cromo
- Recta roscable
- Material de latón
- Cierre compresión



FIGURA	ACABADO	CONT. MASTER	PRECIO UNITARIO	FIGURA	MEDIDA	CONT. MASTER	PRECIO UNITARIO
25-IG	SATINADO	100	\$240.46	25-IR	13X10 mm	100	\$205.65
				25-IR	13X13 mm	200	\$205.65



- Conexión hembra-macho
- Material de latón
- Cierre compresión
- Medida 13x22 mm



- Conexión hembra-macho
- Material de latón
- Cierre compresión
- Medida 13x22 mm



- Conexión hembra-macho
- Material de latón
- Cierre compresión
- Medida 13x22 mm



FIGURA	ACABADO	CONT. MTR	PRECIO UNIT.	FIGURA	ACABADO	CONT. MTR	PRECIO UNIT.	FIGURA	ACABADO	CONT. MTR	PRECIO UNIT.
66	CROMO	50	\$305.10	66-B	SIN PULIR	100	\$170.85	66-BS	SATINADO	50	\$207.39



- Conexión hembra-macho
- Material de latón
- Cierre compresión
- Medida 13x13 mm



- Conexión macho
- Material de latón
- Cierre compresión
- Medida 13x22 mm



- Conexión hembra-macho
- Material de latón
- Cierre 90°
- Acabado satinado



FIGURA	ACABADO	CONT. MTR	PRECIO UNIT.	FIGURA	ACABADO	CONT. MTR	PRECIO UNIT.	FIGURA	MEDIDA	CONT. MTR	PRECIO UNIT.
66-C	CROMO	120	\$297.41	66-G	SIN PULIR	100	\$349.45	66-MS	13X22 mm	150	\$164.52
								66-MS	13X13 mm	150	\$149.68



Estos precios **NO** incluyen I.V.A.-Esta lista sustituye a las anteriores-Sujetos a cambios sin previo aviso.

La información e imágenes contenidas pueden sufrir cambios sin previo aviso, por motivos de actualización y mejora continua sin responsabilidad alguna por la marca o su publicidad

CALENTADOR DE PASO INSTANTÁNEO DE AGUA

BAJA PRESIÓN

AHORRO 70% GAS



4
AÑOS DE GARANTÍA
EN CALENTADOR

- 1 servicio
- Doble válvula de seguridad



FIGURA **CPI-06** CONT. MASTER 1 PRECIO UNITARIO \$4,268.11

- 11/2 servicios
- Doble válvula de seguridad



FIGURA **CPI-08** CONT. MASTER 1 PRECIO UNITARIO \$6,602.64

- 2 servicios
- Doble válvula de seguridad



FIGURA **CPI-12** CONT. MASTER 1 PRECIO UNITARIO \$9,810.96

NOM ANCE NOM-003-ENER-2011
NOM-200-SCFI-2017

VÁLVULA DE GAS

- Cero presión



FIGURA **RCP-01** CONT. MTR 50 PRECIO UNIT. \$461.93

MODULO GENERADOR

- De impulsos eléctricos



FIGURA **RCP-02** 1 SELENOIDE 50 \$482.37
FIGURA **RCP-02** 2 SELENOIDES 50 \$482.37

CAJA PLÁSTICA

- De baterías



FIGURA **RCP-03** CONT. MTR 200 PRECIO UNIT. \$104.41

VÁLVULA

- Electromagnética



FIGURA **RCP-04** CONT. MTR X PRECIO UNIT. \$363.85

MANERAL DE PLÁSTCO

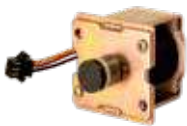

FIGURA **RCP-05** CONT. MTR X PRECIO UNIT. \$41.13

SENSOR DE FLUJO



FIGURA **RCP-06** CONT. MTR 300 PRECIO UNIT. \$585.32

SENSOR DE TEMPERATURA



FIGURA **RCP-07** CONT. MTR X PRECIO UNIT. \$72.77

INTERRUPTOR DE ENCENDIDO



FIGURA **RCP-08** CONT. MTR X PRECIO UNIT. \$79.10

Estos precios **NO** incluyen I.V.A.-Esta lista sustituye a las anteriores-Sujetos a cambios sin previo aviso.

La información e imágenes contenidas pueden sufrir cambios sin previo aviso, por motivos de actualización y mejora continua sin responsabilidad alguna por la marca o su publicidad

ALIMENTADORES MAXIFLEX DE ALUMINIO

- Para lavabo y fregadero
- Tuercas Metálicas e Inserto de latón



FIGURA	MEDIDA	CONT.	MTR	PRECIO UNIT.
25-ME	40 cm	200		\$57.32
	55 cm	200		\$65.49
	60 cm	200		\$69.29
	70 cm	200		\$72.77
	80 cm	200		\$77.85
	100 cm	200		\$93.18

1/2" 1/2"

- Para lavabo y fregadero
- Tuercas Metálicas e Inserto de latón



FIGURA	MEDIDA	CONT.	MTR	PRECIO UNIT.
25-ME	40 cm	200		\$59.99
	55 cm	200		\$66.44

3/8" 1/2"



1/2" 1/2" 1/2"

- Para lavabo y fregadero
- Tuercas Metálicas e Inserto de latón

FIGURA	MEDIDA	CONT.	MTR	PRECIO UNIT.
25-MET	55 cm	50		\$238.95

- Para W.C.
- Tuercas Metálicas e Inserto de latón



FIGURA	MEDIDA	CONT.	MTR	PRECIO UNIT.
67-ME	35 cm	200		\$58.61
	50 cm	200		\$74.92
	60 cm	200		\$86.44

1/2" 1/8"

- Para W.C.
- Tuercas Metálicas e Inserto de latón



FIGURA	MEDIDA	CONT.	MTR	PRECIO UNIT.
67-ME	35 cm	200		\$74.69
	50 cm	200		\$80.01

1/8" 1/8"

- Para W.C.
- Tuercas Metálica de 1/2" y tuerca de plástico de 7/8"



FIGURA	MEDIDA	CONT.	MTR	PRECIO UNIT.
67-MF	35 cm	50		\$56.81

1/2" 7/8"

- Tuercas Metálica (3/8") - Plástico (7/8")
- Inserto de latón - Plástico



FIGURA	MEDIDA	CONT.	MTR	PRECIO UNIT.
67-MF	40 cm	50		\$58.19

3/8" 7/8"



Estos precios **NO** incluyen I.V.A.-Esta lista sustituye a las anteriores-Sujetos a cambios sin previo aviso.

La información e imágenes contenidas pueden sufrir cambios sin previo aviso, por motivos de actualización y mejora continua sin responsabilidad alguna por la marca o su publicidad

ALIMENTADORES MAXIFLEX DE ACERO INOXIDABLE

- Para lavabo y fregadero
- Tuercas e Inserto de latón



FIGURA	MEDIDA	CONT. MTR	PRECIO UNIT.
25-MA	40 cm	200	\$107.57
	55 cm	200	\$116.91
	100 cm	200	\$125.00

- Para monomando, lavabo y fregadero
- Tuercas e Inserto de latón



FIGURA	MEDIDA	CONT. MTR	PRECIO UNIT.
25-MX	55 cm	200	\$135.26

- Para W.C
- Tuercas e Inserto de latón



FIGURA	MEDIDA	CONT. MTR	PRECIO UNIT.
67-MA	35 cm	200	\$111.06

- Para W.C
- Tuercas e Inserto de latón



FIGURA	MEDIDA	CONT. MTR	PRECIO UNIT.
67-MA	35 cm	200	\$117.22

ALIMENTADORES MAXIFLEX DE VINILO

- Para lavabo y fregadero
- Tuercas e Inserto de latón



FIGURA	MEDIDA	CONT. MTR	PRECIO UNIT.
25-V	40 cm	200	\$91.75
	55 cm	200	\$96.18

- Para lavabo y fregadero
- Tuercas de plástico
- Inserto de latón



FIGURA	MEDIDA	CONT. MTR	PRECIO UNIT.
25-V	40 cm	200	\$63.12
	55 cm	200	\$75.14

- Para W.C
- Tuercas de latón-plástico
- Inserto de latón-latón



FIGURA	MEDIDA	CONT. MTR	PRECIO UNIT.
67-V	35 cm	200	\$74.84

- Para W.C
- Tuercas de plástico
- Inserto de latón-latón



FIGURA	MEDIDA	CONT. MTR	PRECIO UNIT.
67-V	35 cm	200	\$66.13

- Para W.C
- Tuercas de latón-plástico
- Inserto de latón



FIGURA	MEDIDA	CONT. MTR	PRECIO UNIT.
67-V	35 cm	200	\$86.93

- Para W.C
- Tuercas plástico
- Inserto de latón



FIGURA	MEDIDA	CONT. MTR	PRECIO UNIT.
67-V	35 cm	200	\$58.55

Estos precios **NO** incluyen I.V.A.-Esta lista sustituye a las anteriores-Sujetos a cambios sin previo aviso.
La información e imágenes contenidas pueden sufrir cambios sin previo aviso, por motivos de actualización y mejora continua sin responsabilidad alguna por la marca o su publicidad

ALIMENTADORES MAXIBOILER DE ALUMINIO

- Para boiler
- Tuercas e inserto de latón



FIGURA	MEDIDA	CONT.	MTR	PRECIO UNIT.
25-B	40 cm	96		\$154.79
	60 cm	96		\$171.33
	80 cm	72		\$210.56

- Para boiler
- Tuercas e inserto de latón



FIGURA	MEDIDA	CONT.	MTR	PRECIO UNIT.
25-B	40 cm	96		\$176.10
	60 cm	96		\$198.38
	80 cm	72		\$237.61

- Para boiler
- Tuercas e inserto de latón
- Hembra-Hembra



FIGURA	MEDIDA	CONT.	MTR	PRECIO UNIT.
25-BHH	60 cm	96		\$141.27
	80 cm	72		\$168.45

- Para boiler
- Tuercas e inserto de latón
- Hembra-Macho



FIGURA	MEDIDA	CONT.	MTR	PRECIO UNIT.
25-BMH	80 cm	72		\$169.46

ALIMENTADORES MAXIBOILER DE ACERO INOXIABLE

- Para boiler
- Tuercas e inserto de latón



FIGURA	MEDIDA	CONT.	MTR	PRECIO UNIT.
25-BA	60 cm	96		\$181.85

- Para boiler
- Tuercas e inserto de latón



FIGURA	MEDIDA	CONT.	MTR	PRECIO UNIT.
25-BA	60 cm	96		\$215.15
	80 cm	72		\$240.04

ALIMENTADORES MAXIGAS DE ALUMINIO

- Para gas
- Tuercas e Inserto de latón



FIGURA	MEDIDA	CONT.	MTR	PRECIO UNIT.
25-GN	60 cm	75		\$149.68
	100 cm	50		\$171.33
	150 cm	25		\$207.39
	200 cm	30		\$237.45



- Para gas
- Tuercas e Inserto de latón



FIGURA	MEDIDA	CONT.	MTR	PRECIO UNIT.
25-GN	60 cm	75		\$126.24
	100 cm	50		\$156.30
	150 cm	25		\$189.36
	200 cm	30		\$228.43



Estos precios **NO** incluyen I.V.A.-Esta lista sustituye a las anteriores-Sujetos a cambios sin previo aviso.
La información e imágenes contenidas pueden sufrir cambios sin previo aviso, por motivos de actualización y mejora continua sin responsabilidad alguna por la marca o su publicidad

ALIMENTADORES DE ALUMINIO USOS GENERALES

• Tuercas e inserto de latón



3/8" 3/8"

FIGURA	MEDIDA	CONT. MTR	PRECIO UNIT.
25-GN	300 cm	20	\$332.21
	400 cm	10	\$375.71
	500 cm	10	\$471.74
	1000 cm	5	\$895.70

• Tuercas e inserto de latón



5/16" 5/16"

FIGURA	MEDIDA	CONT. MTR	PRECIO UNIT.
25-GN	300 cm	20	\$309.24
	400 cm	10	\$354.67
	500 cm	10	\$452.44
	1000 cm	5	\$868.65

• Tuercas e inserto de latón



3/8" 3/8"

FIGURA	MEDIDA	CONT. MTR	PRECIO UNIT.
25-GNI	60 cm	75	\$100.99
	100 cm	50	\$131.68
	150 cm	25	\$141.27
	200 cm	30	\$159.30
	300 cm	20	\$223.06
	400 cm	10	\$270.51
	500 cm	10	\$311.99
	1000 cm	5	\$749.21

• Tuercas e inserto de latón



5/16" 5/16"

FIGURA	MEDIDA	CONT. MTR	PRECIO UNIT.
25-GNI	60 cm	75	\$97.70
	100 cm	50	\$114.53
	150 cm	25	\$145.54
	200 cm	30	\$174.01
	300 cm	20	\$250.94
	400 cm	10	\$287.31
	500 cm	10	\$381.88
	1000 cm	5	\$772.44

ALIMENTADORES USO GENERAL DE ACERO INOXIDABLE 304

• Tuercas e inserto de latón



3/8" 3/8"

FIGURA	MEDIDA	CONT. MTR	PRECIO UNIT.
25-GNA	60 cm	75	\$114.19
	100 cm	50	\$164.52
	150 cm	25	\$177.34
	200 cm	30	\$239.86
	300 cm	20	\$281.59
	500 cm	10	\$426.81

• Tuercas e inserto de latón



5/16" 5/16"

FIGURA	MEDIDA	CONT. MTR	PRECIO UNIT.
25-GNA	60 cm	75	\$111.21
	100 cm	50	\$145.48
	150 cm	25	\$161.80
	200 cm	30	\$189.36
	300 cm	20	\$259.44
	500 cm	10	\$429.15



Estos precios **NO** incluyen I.V.A.-Esta lista sustituye a las anteriores-Sujetos a cambios sin previo aviso.

La información e imágenes contenidas pueden sufrir cambios sin previo aviso, por motivos de actualización y mejora continua sin responsabilidad alguna por la marca o su publicidad

KIT-B4

- Para boiler



FIGURA	CANTIDAD	MEDIDA	DESCRIPCIÓN
25-BA	2	3/4"x3/4"x60 cm	MAXIBOILER ACERO INOXIDABLE
100-I	1	13 mm	VÁLVULA DE ESFERA DE LATÓN
4-N	1	1/2"x3/8"	VÁLVULA DE PASO DE LATÓN
28-FR	1	3/8"x1/2"	NIPLE TERMINAL
25-GNI	1	3/8"x3/8"x60cm	ALIMENTADOR FLEXIBLE
97-RB	1	3/4"x1/2"	REDUCCIÓN BUSH EN BRONCE
97-NR	1	3/4"x1/2"	NIPLE REDUCCIÓN EN BRONCE
CTI	1	1/2"x260"	CINTA DE TEFLÓN

CONT. MASTER 10 PRECIO UNIT. \$1,072.56



KIT-CP 3/8"

- Para calentador de paso
- Medida de 1/2"x3/8"



FIGURA	CANTIDAD	MEDIDA	DESCRIPCIÓN
25-BHH	2	1/2"x1/2"x80 cm	MANGUERA P/CALENTADOR HEMBRA-HEMBRA
66MS	1	13 mm	VÁLVULA DE ESFERA DE LATÓN ROSCADA
4-N	1	1/2"x3/8"	VÁLVULA DE PASO DE LATÓN
26-FR	1	1/2"x3/8"	NIPLE CAMPANA DE LATÓN
25-GNI	1	3/8"x3/8"x100 cm	ALIMENTADOR FLEXIBLE
CTI	1	1/2"x260"	CINTA DE TEFLÓN

CONT. MASTER 10 PRECIO UNIT. \$838.44



KIT-CP 5/16"

- Para calentador de paso
- Medida de 1/2"x5/16"



FIGURA	CANTIDAD	MEDIDA	DESCRIPCIÓN
25-BHH	2	1/2"x1/2"x80 cm	MANGUERA P/CALENTADOR HEMBRA-HEMBRA
66MS	1	1/2"x1/2"x80 cm	VÁLVULA DE ESFERA DE LATÓN ROSCADA
4-N	1	13 mm	VÁLVULA DE PASO DE LATÓN
26-FR	1	1/2"x5/16"	NIPLE CAMPANA DE LATÓN
25-GNI	1	1/2"x5/16"	ALIMENTADOR FLEXIBLE
CTI	1	5/16"x5/16"x100 cm	CINTA DE TEFLÓN

CONT. MASTER 10 PRECIO UNIT. \$791.16



KIT-F1

- Para mezcladora



FIGURA	CANTIDAD	MEDIDA	DESCRIPCIÓN
25-ME	2	13x13x55 cm	MAXIFLEX PARA LAVABO
25-E	2	13x13 mm	LLAVE DE CONTROL SIN TUBO Y SIN TUERCA
CTI	1	1/2"x260"	CINTA DE TEFLÓN

CONT. MASTER 20 PRECIO UNIT. \$327.62



KIT-F2

- Para tarja de tina



FIGURA	CANTIDAD	MEDIDA	DESCRIPCIÓN
25-ME	2	13x13x55 cm	MAXIFLEX PARA FREGADERO
25-E	2	13x13 mm	LLAVE DE CONTROL SIN TUBO Y SIN TUERCA
11-R	1	42.5x20x6 cm	TRAMPA P/LAV.O FREG. C/REG. S/CONTRA
11-U	1	33x20x10.5 cm	CONECTOR 56A A CESPOL HULE 38 MM
13-PP	1	11.4x6.4x13.4 cm	CONTRA CANASTA A.B.S.
CTI	1	1/2"x260"	CINTA DE TEFLÓN

CONT. MASTER 10 PRECIO UNIT. \$503.06



KIT-F3

- Para tarja de tina



FIGURA	CANTIDAD	MEDIDA	DESCRIPCIÓN
25-ME	2	13x13x55 cm	MAXIFLEX PARA FREGADERO
25-E	2	13x13 mm	LLAVE DE CONTROL SIN TUBO Y SIN TUERCA
11-R	1	42.5x20x6 cm	TRAMPA P/LAV.O FREG. C/REG. S/CONTRA
11-U	1	33x20x10.5 cm	CONECTOR CESPOL HULE 38 MM
13-IP	1	5.7x11.5x14 cm	CONTRA CANASTA AC.INOX. C/TUBO DE PLÁSTICO
CTI	1	1/2"x260"	CINTA DE TEFLÓN

CONT. MASTER 10 PRECIO UNIT. \$569.50



KIT-F4

- Para tarja de doble tina



FIGURA	CANTIDAD	MEDIDA	DESCRIPCIÓN
25-ME	2	13x13x55 cm	MAXIFLEX PARA FREGADERO
25-E	2	13x13 mm	LLAVE DE CONTROL SIN TUBO Y SIN TUERCA
11-R	1	42.5x20x6 cm	TRAMPA P/LAV.O FREG. C/REG. S/CONTRA
11-U	1	33x20x10.5 cm	CONECTOR CESPOL HULE 38 MM
11-EP	1	10.5x26.5x9 cm	SALIDA CENTRAL P.V.C. P/TARJA DOBLE TINA
13-PP	2	11.4x6.4x13.4 cm	CONTRA CANASTA A.B.S.
CTI	1	1/2"x260"	CINTA DE TEFLÓN

CONT. MASTER 6 PRECIO UNIT. \$673.91



KIT-F5

- Para tarja de doble tina



FIGURA	CANTIDAD	MEDIDA	DESCRIPCIÓN
25-ME	2	13x13x55 cm	MAXIFLEX PARA FREGADERO
25-E	2	13x13 mm	LLAVE DE CONTROL SIN TUBO Y SIN TUERCA
11-R	1	42.5x20x6 cm	TRAMPA P/LAV.O FREG. C/REG. S/CONTRA
11-U	1	33x20x10.5 cm	CONECTOR CESPOL HULE 38 MM
11-EP	1	10.5x26.5x9 cm	SALIDA CENTRAL P.V.C. P/TARJA DOBLE TINA
13-IP	2	5.7x11.5x14 cm	CONTRA CANASTA ACERO INOX.
CTI	1	1/2"x260"	CINTA DE TEFLÓN

CONT. MASTER 6 PRECIO UNIT. \$889.06



Estos precios **NO** incluyen I.V.A.-Esta lista sustituye a las anteriores-Sujetos a cambios sin previo aviso.

La información e imágenes contenidas pueden sufrir cambios sin previo aviso, por motivos de actualización y mejora continua sin responsabilidad alguna por la marca o su publicidad

KITS DE INSTALACIÓN

KIT-F8

- Para tarja de una tina
- Incluye mezcladora



FIGURA	CANTIDAD	MEDIDA	DESCRIPCIÓN
25-ME	2	13x13x55 cm	MAXIFLEX PARA FREGADERO
25-E	2	13x13 mm	LLAVE DE CONTROL SIN TUBO Y SIN TUERCA
11-R	1	42.5x20x10.5 cm	TRAMPA P/LAV.O FREG. C/REG. S/CONTRA
11-U	1	33x20x10.5 cm	CONECTOR CESPOL HULE 38 MM
13-PP	1	11.4x6.4x13.4 cm	CONTRA CANASTA A.B.S.
CTI	1	1/2"x260	CINTA DE TEFLÓN
8-I	1	31.7x12.4x6	MEZCLADORA P/FREG. AL PISO C/CUBIERTA
			CONT. MASTER 8 PRECIO UNIT. \$1,344.66



KIT-F9

- Para tarja de una tina
- Incluye mezcladora



FIGURA	CANTIDAD	MEDIDA	DESCRIPCIÓN
25-ME	2	13x13x55 cm	MAXIFLEX PARA FREGADERO
25-E	2	13x13 mm	LLAVE DE CONTROL SIN TUBO Y SIN TUERCA
11-R	1	42.5x20x10.5 cm	TRAMPA P/LAV.O FREG. C/REG. S/CONTRA
11-U	1	33x20x10.5 cm	CONECTOR CESPOL HULE 38 MM
11-EP	1	11.4x6.4x13.4 cm	SALIDA CENTRAL P.V.C. P/TARJA DOBLE TINA
13-PP	2	11.4x6.4x13.4	CONTRA CANASTA A.B.S.
CTI	1	1/2"x260	CINTA DE TEFLÓN
8-I	1	31.7x12.4x6	MEZCLADORA P/FREG. AL PISO C/CUBIERTA
			CONT. MASTER 4 PRECIO UNIT. \$1,512.35



KIT-L1

- Para lavabo



FIGURA	CANTIDAD	MEDIDA	DESCRIPCIÓN
25-ME	2	13x13x40 cm	MAXIFLEX PARA LAVABO
25-E	2	13x13 mm	LLAVE DE CONTROL SIN TUBO Y SIN TUERCA
29-R	1	24x17x4.5 cm	CESPOL PARA LAVABO P.V.C. CON REGISTRO
29-U	1	10.5x25x37.5 cm	CONECTOR 56A CESPOL HULE 32 MM
CTI	1	1/2"x260	CINTA DE TEFLÓN
			CONT. MASTER 25 PRECIO UNIT. \$408.18



KIT-L2

- Para mezcladora



FIGURA	CANTIDAD	MEDIDA	DESCRIPCIÓN
25-ME	2	13x13x40 cm	MAXIFLEX PARA LAVABO
25-E	2	13x13 mm	LLAVE DE CONTROL SIN TUBO Y SIN TUERCA
CTI	1	1/2"x260	CINTA DE TEFLÓN
			CONT. MASTER 30 PRECIO UNIT. \$338.54



KIT-L3

- Para lavabo
- Incluye mezcladora



FIGURA	CANTIDAD	MEDIDA	DESCRIPCIÓN
24-Q	1	6.5x14.5x15.5	MEZC. P/LAVABO DE 4" MANERAL TAURO
29-R	1	24x17x4.5 cm	CESPOL PARA LAVABO P.V.C. CON REGISTRO
25-ME	2	13x13x40 cm	MAXIFLEX 1/2"x1/2"x40 cm P/LAVABO
29-U	1	10.5x25x37.5 cm	CONECTOR 56A A CESPOL HULE 32 MM
25-E	2	13x13 mm	LLAVE DE CONTROL SIN TUBO Y SIN TUERCA
CTI	1	1/2"x260	CINTA DE TEFLÓN
			CONT. MASTER 12 PRECIO UNIT. \$1,213.20



KIT-L4

- Para lavabo



FIGURA	CANTIDAD	MEDIDA	DESCRIPCIÓN
25-ME	2	13x13x40 cm	MAXIFLEX 1/2"x1/2"x40 cm P/LAVABO
25-E	2	1/2"x1/2" mm	LLAVE DE CONTROL SIN TUBO Y SIN TUERCA
28-PTF	1	30x19x5.5 cm	CESPOL FLEXIBLE DE PP PARA LAVABO
29-U	1	10.5x25x37.5 cm	CONECTOR 56A A CESPOL HULE 32 MM
CTI	1	1/2"x260	CINTA DE TEFLÓN
			CONT. MASTER x PRECIO UNIT. \$395.49



KIT-M1

- Para fregadero monomando



FIGURA	CANTIDAD	MEDIDA	DESCRIPCIÓN
12000	1	1/2"x1/2"	MEZC. MONOMANDO A.B.S. P/FREG A/CROMO
26-T	2	36x25.5x18 cm	CUBRE TALADRO SEPARADO LISO AC. INOX
13-PP	1	11.4x6.4x13.4 cm	CONTRA CANASTA A.B.S.
9-TSEM	1	48x48 cm	TARJA DE AC. INOX. PARA MONOMANDO
			CONT. MASTER 12 PRECIO UNIT. \$1,803.05



KIT-MM

- Para lavabo



FIGURA	CANTIDAD	MEDIDA	DESCRIPCIÓN
29-D	1	1 1/4"	MEDIA TRAMPA DE LATÓN PARA LAVABO
25-E	2	13x13 mm	LLAVE DE CONTROL SIN TUBO Y SIN TUERCA
CTI	1	1/2"x260	CINTA DE TEFLÓN
			CONT. MASTER 6 PRECIO UNIT. \$597.98



KIT-W1

- Para W.C.



FIGURA	CANTIDAD	MEDIDA	DESCRIPCIÓN
25-E	1	13x13 mm	LLAVE DE CONTROL SIN TUBO Y SIN TUERCA
67-ME	1	13x22x35 cm	MAXIFLEX PARA W.C.
58-AG	1	15x14x14	CUELLO DE CERA CON GUÍA DE PLÁSTICO
62	2	12x23x3 cm	PIJAS PARA W.C.
CTI	1	1/2"x260	CINTA DE TEFLÓN
			CONT. MASTER 25 PRECIO UNIT. \$240.55



ASI-05

- Para W.C.









FIGURA	ACABADO	CONT. MASTER	PRECIO UNIT.
ASI-04	MARFIL	5	\$1,202.28
ASI-05	BLANCO	5	\$1,202.28



Estos precios **NO** incluyen I.V.A.-Esta lista sustituye a las anteriores-Sujetos a cambios sin previo aviso.

La información e imágenes contenidas pueden sufrir cambios sin previo aviso, por motivos de actualización y mejora continua sin responsabilidad alguna por la marca o su publicidad

VÁLVULAS DE ADMISIÓN W.C.

 <p>FIGURA 50</p>	<ul style="list-style-type: none"> • Material de bronce <p>CONT. MASTER 25</p> <p>PRECIO UNITARIO \$519.39</p> <p>HECHO EN MÉXICO NOM</p>	 <p>FIGURA 50 ASIENTO CAMBIABLE</p>	<ul style="list-style-type: none"> • Material de bronce • Asiento cambiabile <p>CONT. MASTER 25</p> <p>PRECIO UNITARIO \$594.81</p> <p>HECHO EN MÉXICO NOM</p>
 <p>FIGURA 50-P</p>	<ul style="list-style-type: none"> • Material A.B.S. <p>CONT. MASTER 120</p> <p>PRECIO UNITARIO \$99.35</p> <p>HECHO EN MÉXICO NOM</p>	 <p>FIGURA 50-PA</p>	<ul style="list-style-type: none"> • Material de polipropileno • Altura ajustable <p>CONT. MASTER 25</p> <p>PRECIO UNITARIO \$316.92</p> <p>NOM</p>
 <p>FIGURA 50-PAB</p>	<ul style="list-style-type: none"> • Material de polipropileno • Altura ajustable <p>CONT. MASTER 20</p> <p>PRECIO UNITARIO \$330.03</p> <p>NOM</p>	 <p>FIGURA 50-PB</p>	<ul style="list-style-type: none"> • Material de polipropileno • Altura ajustable <p>CONT. MASTER 20</p> <p>PRECIO UNITARIO \$237.45</p> <p>NOM</p>

VÁLVULAS DE DESCARGA W.C.

 <p>FIGURA 52</p>	<ul style="list-style-type: none"> • Material de bronce • Contra de bronce <p>CONT. MASTER 25</p> <p>PRECIO UNITARIO \$640.40</p> <p>HECHO EN MÉXICO NOM</p>	 <p>FIGURA 52-DBA</p>	<ul style="list-style-type: none"> • Material de polipropileno • Dual flush <p>CONT. MASTER 20</p> <p>PRECIO UNITARIO \$405.52</p> <p>NOM</p>
 <p>FIGURA 52-DLT</p>	<ul style="list-style-type: none"> • Material de polipropileno • Dual flush • Con botón lateral / frontal <p>CONT. MASTER 20</p> <p>PRECIO UNITARIO \$505.53</p> <p>NOM</p>	 <p>FIGURA 52-P</p>	<ul style="list-style-type: none"> • Material de A.B.S. <p>CONT. MASTER 100</p> <p>PRECIO UNITARIO \$85.05</p> <p>HECHO EN MÉXICO NOM</p>

Estos precios **NO** incluyen I.V.A.-Esta lista sustituye a las anteriores-Sujetos a cambios sin previo aviso.
La información e imágenes contenidas pueden sufrir cambios sin previo aviso, por motivos de actualización y mejora continua sin responsabilidad alguna por la marca o su publicidad

JUEGO DE HERRAJES Y ACCESORIOS W.C.



- Material de bronce
- Juego completo de herrajes W.C.

FIGURA 72 **CONT. MASTER 10** **PRECIO UNITARIO \$1,470.42**

HECHO EN MÉXICO **NOM**
NOM aplica p/fig. 50 y 52



- Material de polipropileno
- Juego completo de herrajes W.C.

FIGURA 72-P **CONT. MASTER 30** **PRECIO UNITARIO \$189.63**

HECHO EN MÉXICO **NOM**
NOM aplica p/fig. 50-P y 52-P



- Material de polipropileno
- Juego de accesorios para W.C.

FIGURA 72-PAD **CONT. MASTER 5** **PRECIO UNITARIO \$869.22**

NOM
NOM aplica p/fig. 50-PAB y 52-DLT



- Material de polipropileno
- Juego de accesorios para W.C.

FIGURA 72-PBP **CONT. MASTER 5** **PRECIO UNITARIO \$366.58**

NOM
NOM aplica p/fig. 50-PB y 52-P

BOTÓN DUAL FLUSH



- Material de polipropileno
- Alto para figura 52-DBA
- Medida de 38mm Ø

FIGURA BT-38 **CONT. MASTER 150** **PRECIO UNITARIO \$120.02**



- Material de polipropileno
- Alto para figura 52-DBA
- Medida de 48mm Ø

FIGURA BT-48 **CONT. MASTER 200** **PRECIO UNITARIO \$125.92**

MANIVELAS



- Manivela metálica
- Varilla de acero tropicalizado
- Pivote metálico
- Tuerca metálica

FIGURA 60-I **ACABADO CROMO** **CONT. MASTER 200** **PRECIO UNITARIO \$68.98**



- Manivela metálica
- Varilla de acero tropicalizado
- Pivote metálico
- Tuerca de plástico











FIGURA 60-IP **ACABADO CROMO** **CONT. MASTER 200** **PRECIO UNITARIO \$56.81**

Estos precios **NO** incluyen I.V.A.-Esta lista sustituye a las anteriores-Sujetos a cambios sin previo aviso.
La información e imágenes contenidas pueden sufrir cambios sin previo aviso, por motivos de actualización y mejora continua sin responsabilidad alguna por la marca o su publicidad

MANIVELAS

	<ul style="list-style-type: none"> • Manivela de A.B.S. • Varilla de A.B.S. • Pivote plástico • Tuerca plástico 						
FIGURA 60-IPP	ACABADO CROMO	CONT. MASTER 200	PRECIO UNITARIO \$44.10		<ul style="list-style-type: none"> • Manivela lateral metálica • Varilla de latón 		
				FIGURA 60-KO	ACABADO CROMO	CONT. MASTER 30	PRECIO UNITARIO \$200.12
	<ul style="list-style-type: none"> • Manivela lateral metálica • Varilla de latón • Botón de A.B.S. 						
FIGURA 60-PL	ACABADO CROMO	CONT. MASTER 50	PRECIO UNITARIO \$240.17		<ul style="list-style-type: none"> • Manivela metálica • Fig. 60-R Varilla de acero latonado • Fig. 60-RL Varilla de bronce 		
				FIGURA 60-R 60-RL	CONT. MASTER CROMO CROMO	CONT. MASTER 200 100	PRECIO UNITARIO \$103.70 \$147.50

ACCESORIOS

PERA PERFECTA				SAPITO CON CADENA			
	<ul style="list-style-type: none"> • Para W.C. 				<ul style="list-style-type: none"> • Para W.C. 		
FIGURA 55	CONT. MASTER 100	PRECIO UNITARIO \$35.80		FIGURA 55-I	CONT. MASTER 200	PRECIO UNITARIO \$50.95	
SAPITO				VARILLA			
	<ul style="list-style-type: none"> • Para W.C. 				<ul style="list-style-type: none"> • Para flotador • Material de latón 		
FIGURA 55-P	CONT. MASTER 180	PRECIO UNITARIO \$34.44		FIGURA 57	MEDIDA 1/4" x 6" LONG 1/4" x 9" LONG 1/4" x 12" LONG	CONT. MASTER 100 100 100	PRECIO UNITARIO \$48.15 \$72.14 \$92.07
FLOTADOR				FLOTADOR			
	<ul style="list-style-type: none"> • Material de plástico • Medida 4" • Para W.C. 				<ul style="list-style-type: none"> • Material de plástico • Medida 6" • Para tinaco 		
FIGURA 58	CONT. MASTER 100	PRECIO UNITARIO \$14.88		FIGURA 58-T	CONT. MASTER 60	PRECIO UNITARIO \$39.87	

Estos precios **NO** incluyen I.V.A.-Esta lista sustituye a las anteriores-Sujetos a cambios sin previo aviso.

La información e imágenes contenidas pueden sufrir cambios sin previo aviso, por motivos de actualización y mejora continua sin responsabilidad alguna por la marca o su publicidad

ACCESORIOS



CUELLO DE CERA

- Sin guía para W.C.



FIGURA
58-A

CONT. MASTER
44

PRECIO UNITARIO
\$48.25



CUELLO DE CERA

- Con guía para W.C.



FIGURA
58-AG

CONT. MASTER
24

PRECIO UNITARIO
\$52.60



JUEGO DE TORNILLO

- Con mariposa
- Material de bronce
- Para tanque taza



FIGURA
61

CONT. MASTER
50

PRECIO UNITARIO
\$136.05



JUEGO DE TORNILLO

- Con mariposa
- Material hierro topicalizado
- Para tanque taza



FIGURA
61-FT

CONT. MASTER
150

PRECIO UNITARIO
\$29.46



PIJA

- Para W.C.



FIGURA
62

CONT. MASTER
100

PRECIO UNITARIO
\$9.43



HULE ESPONJOSO

- Para tanque taza



FIGURA
HE

MEDIDA
2" (51 mm)
3" (76 mm)

CONT. MASTER
50
50

PRECIO UNITARIO
\$22.88
\$47.46



SOPORTE

- Para lavabo
- Material hierro galvanizado



FIGURA
SL-1

CONT. MASTER
500

PRECIO UNITARIO
\$10.52



SOPORTE

- Para lavabo
- Material hierro fundido



FIGURA
SL-F

CONT. MASTER
100

PRECIO UNITARIO
\$40.28

LLAVES PARA LAVANDERÍA



- Material de latón
- Pico terminal
- Cierre compresión
- Medida de 13 mm



FIGURA
1

ACABADO
CROMO

CONT. MASTER
100

PRECIO UNITARIO
\$231.44



- Material de latón
- Pico terminal
- Cierre compresión
- Medida de 13 mm
- Peso 240 grs



FIGURA
1-GC

ACABADO
CROMO

CONT. MASTER
100

PRECIO UNITARIO
\$487.24

Estos precios **NO** incluyen I.V.A.-Esta lista sustituye a las anteriores-Sujetos a cambios sin previo aviso.
La información e imágenes contenidas pueden sufrir cambios sin previo aviso, por motivos de actualización y mejora continua sin responsabilidad alguna por la marca o su publicidad

LLAVES PARA LAVANDERÍA



- Material de latón
- Con rosca para manguera
- Cierre compresión
- Medida de 13 mm



FIGURA 2 **ACABADO CROMO** **CONT. MASTER 120** **PRECIO UNITARIO \$227.80**



- Material de latón
- Con rosca para manguera
- Cierre compresión
- Medida de 13 mm
- Peso 240 grs



FIGURA 2-GC **ACABADO CROMO** **CONT. MASTER 100** **PRECIO UNITARIO \$407.04**

LLAVES PARA JARDÍN



- Material de bronce
- Con rosca para manguera
- Cierre compresión
- Medida de 13 mm



FIGURA 2-A **ACABADO SIN PULIR** **CONT. MASTER 50** **PRECIO UNITARIO \$189.20**



- Material de latón
- Con rosca para manguera
- Cierre 90°
- Medida de 13 mm



FIGURA 2-AL **ACABADO SIN PULIR** **CONT. MASTER 100** **PRECIO UNITARIO \$262.60**



- Material de latón
- Con rosca para manguera
- Cierre compresión
- Medida de 13 mm



FIGURA 2-AS **ACABADO SATINADO** **CONT. MASTER 200** **PRECIO UNITARIO \$165.31**



- Material de bronce
- Maneral desmontable
- Con rosca para manguera
- Cierre de compresión
- Medida de 13 mm



FIGURA 2-D **ACABADO SIN PULIR** **CONT. MASTER 100** **PRECIO UNITARIO \$338.54**



- Material de latón
- Con rosca para manguera
- Cierre compresión
- Medida de 13 mm
- Peso 240 grs



FIGURA 2-G **ACABADO SIN PULIR** **CONT. MASTER 100** **PRECIO UNITARIO \$375.18**



- Material de latón
- Con rosca para manguera
- Cierre compresión
- Acabado sin pulir



FIGURA 2-I **ACABADO 13 mm 19 mm** **CONT. MASTER 100** **PRECIO UNITARIO \$115.48 \$183.35**

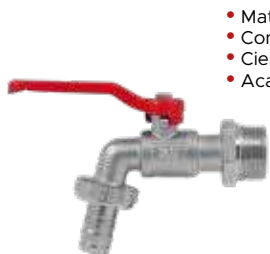

- Material de latón
- Con rosca para manguera
- Cierre 90°
- Acabado satinado



FIGURA 2-IE **MEDIDA 13 mm 19 mm** **CONT. MTR 120 120** **PRECIO UNIT. \$137.81 \$187.59**



- Material de latón
- Con rosca para manguera
- Cierre 90°
- Medida de 13 mm



FIGURA 2-IM **ACABADO SATINADO** **CONT. MTR 200** **PRECIO UNIT. \$170.85**



- Material de latón
- Con rosca para manguera
- Cierre compresión
- Acabado sin pulir



FIGURA B2I **MEDIDA 13 mm** **CONT. MTR 100** **PRECIO UNIT. \$115.48**

Estos precios **NO** incluyen I.V.A.-Esta lista sustituye a las anteriores-Sujetos a cambios sin previo aviso.

La información e imágenes contenidas pueden sufrir cambios sin previo aviso, por motivos de actualización y mejora continua sin responsabilidad alguna por la marca o su publicidad

LLAVES PARA JARDÍN



- Material de latón
- Con rosca para manguera
- Cierre compresión
- Medida de 13 mm



FIGURA 2-IVV ACABADO SIN PULIR CONT. MASTER 160 PRECIO UNITARIO \$138.26



- Material de bronce
- Con rosca para manguera
- Cierre compresión
- Medida de 13 mm



FIGURA 2-R ACABADO SIN PULIR CONT. MASTER 150 PRECIO UNITARIO \$216.41



- Material de latón
- Con rosca para manguera
- Cierre compresión
- Medida de 13 mm



FIGURA 2-RI ACABADO SIN PULIR CONT. MASTER 100 PRECIO UNITARIO \$204.39



VÁLVULA DE ALIVIO PARA BOILER

- Material de bronce
- Con rosca para manguera
- Cierre compresión
- Angular
- Acabado sin pulir



FIGURA 3 3-B MEDIDA 13 mm 19 mm CONT. MASTER 150 150 PRECIO UNITARIO \$226.66 \$257.98

VÁLVULAS



VÁLVULA EXPULSORA DE AIRE

- Material de latón

FIGURA 101 MEDIDA 13 mm CONT. MASTER 100 PRECIO UNITARIO \$240.46



VÁLVULA DE ALIVIO PARA BOILER

- Material de latón
- Apertura 75 P.S.I

FIGURA 3-AB MEDIDA 13 mm 19 mm CONT. MASTER 150 120 PRECIO UNITARIO \$249.47 \$301.86



VÁLVULA DE ALIVIO PARA BOILER

- Material de latón
- Apertura 75 P.S.I
- Compacta

FIGURA 3-ABC MEDIDA 13 mm 19 mm CONT. MASTER 100 200 PRECIO UNITARIO \$132.88 \$187.59



VÁLVULA DE PASO PARA GAS

- Material de latón
- N.P.S. a flare

FIGURA 4-CF MEDIDA 1/2" COMP X 3/8" FLARE CONT. MASTER 100 PRECIO UNITARIO \$168.32



VÁLVULA DE PASO PARA GAS

- Material de bronce
- Flare a flare
- Empacada en caja individual



FIGURA 4-FF MEDIDA 3/8" X 3/8" CONT. MASTER 132 PRECIO UNITARIO \$137.21



VÁLVULA DE PASO PARA GAS

- Material de bronce
- Rosca interior N.P.T. a flare



FIGURA 4-N MEDIDA 1/2" X 5/16" 1/2" X 3/8" CONT. MASTER 250 250 PRECIO UNITARIO \$135.86 \$127.74

Estos precios **NO** incluyen I.V.A.-Esta lista sustituye a las anteriores-Sujetos a cambios sin previo aviso.

La información e imágenes contenidas pueden sufrir cambios sin previo aviso, por motivos de actualización y mejora continua sin responsabilidad alguna por la marca o su publicidad



VÁLVULA DE GLOBO

- Material de bronce
- Cierre compresión
- Roscable



FIGURA	MEDIDA	CONT. MASTER	PRECIO UNITARIO
4-B	1/2"	50	\$163.30
	3/4"	100	\$234.33



VÁLVULA DE GLOBO

- Material de bronce
- Cierre compresión
- Roscable



FIGURA	MEDIDA	CONT. MASTER	PRECIO UNITARIO
73	1/2"	50	\$159.46
	3/4"	50	\$240.46



VÁLVULA DE GLOBO

- Material de latón
- Cierre compresión
- Roscable



FIGURA	MEDIDA	CONT. MASTER	PRECIO UNITARIO
73-I	1/2"	100	\$209.77
	3/4"	100	\$327.62



VÁLVULA DE GLOBO

- Material de bronce
- Cierre compresión
- Soldable



FIGURA	MEDIDA	CONT. MASTER	PRECIO UNITARIO
74	3/4"	40	\$219.67
	1/2"	50	\$132.06



VÁLVULA DE GLOBO

- Material de latón
- Cierre compresión
- Soldable



FIGURA	MEDIDA	CONT. MASTER	PRECIO UNITARIO
74-I	1/2"	100	\$186.35
	3/4"	100	\$325.44



VÁLVULA COMPUERTA

- Material de latón
- Cierre compresión
- Roscable



FIGURA	MEDIDA	CONT. MTR	PRECIO UNIT.
75-AH	1/2"	120	\$186.67
	3/4"	100	\$247.83
	1"	60	\$363.85
	1 1/4"	50	\$563.18
	1 1/2"	30	\$658.25
	2"	20	\$1,018.94
75-AH	2 1/2"	10	\$2,350.78
	3"	8	\$4,033.98
	4"	4	\$5,818.42



VÁLVULA COMPUERTA

- Material de latón
- Cierre compresión
- Soldable



FIGURA	MEDIDA	CONT. MTR	PRECIO UNIT.
75-BH	1/2"	120	\$174.33
	3/4"	100	\$249.95
	1"	60	\$332.21
	1 1/4"	50	\$566.34
	1 1/2"	20	\$598.14
	2"	60	\$1,316.18



VÁLVULA CHECK

- Material de bronce
- De piston
- Roscable

Aplica solo para 1/2", 3/4" y 1"



FIGURA	MEDIDA	CONT. MTR	PRECIO UNIT.
79	1/2"	100	\$278.42
	3/4"	35	\$363.85
	1"	60	\$616.17
	1 1/4"	20	\$1,347.82
	1 1/2"	20	\$1,642.07
	2"	12	\$2,673.50



VÁLVULA CHECK

- Material de latón
- Horizontal
- Roscable

FIGURA	MEDIDA	CONT. MTR	PRECIO UNIT.
79-H	1/2"	120	\$243.62
	3/4"	100	\$340.72
	1"	50	\$444.09
	1 1/4"	40	\$987.14
	2"	12	\$1,819.25



VÁLVULA CHECK

- Material de bronce
- De piston
- Roscable



FIGURA	MEDIDA	CONT. MASTER	PRECIO UNITARIO
79-N	1/2"	70	\$359.18
	3/4"	60	\$433.17

Estos precios **NO** incluyen I.V.A.-Esta lista sustituye a las anteriores-Sujetos a cambios sin previo aviso.

La información e imágenes contenidas pueden sufrir cambios sin previo aviso, por motivos de actualización y mejora continua sin responsabilidad alguna por la marca o su publicidad

VÁLVULA CHECK

- Material de latón
- De resorte
- Roscable



FIGURA	MEDIDA	CONT. MTR	PRECIO UNIT.
79-V	1/2"	200	\$135.86
	3/4"	100	\$194.32
	1"	60	\$291.08
	1 1/4"	40	\$408.78
	1 1/2"	40	\$553.68
	2"	20	\$816.29

CONECTOR E INSERTOR FLOTADOR PARA TINACO

CONECTOR PARA TINACO

- Material de bronce
- Medida 3/4" x 1 1/2" x 1 1/2"



FIGURA	MEDIDA	CONT. MTR	PRECIO UNIT.
92	3/4" x 1 1/2" x 1 1/2"	100	\$372.71

VÁLVULA PARA FLOTADOR

- Material de bronce



Aplica solo para 3/4"

FIGURA	MEDIDA	CONT. MTR	PRECIO UNIT.
93	1/2"	150	\$215.15
	3/4"	75	\$282.54

VÁLVULA PARA FLOTADOR

- Material de latón
- Compacta 1/2"



FIGURA	MEDIDA	CONT. MTR	PRECIO UNIT.
93-C	1/2"	200	\$146.98

INSERTOR PARA TUBO DE PLÁSTICO

- Material de bronce



FIGURA	MEDIDA	CONT. MTR	PRECIO UNIT.
94-B	1/2"	200	\$71.69
	3/4"	100	\$120.23
	1"	60	\$208.82

INSERTOR PARA TUBO DE PLÁSTICO

- Material de latón



FIGURA	MEDIDA	CONT. MTR	PRECIO UNIT.
94-BL	1/2"	500	\$48.09
	3/4"	300	\$82.26
	1"	150	\$147.44

INSERTOR HEMBRA P/TUBO DE PLÁSTICO

- Material de bronce



FIGURA	MEDIDA	CONT. MTR	PRECIO UNIT.
94-BH	3/4"	250	\$142.38

INSERTOR PARA TUBO DE PLÁSTICO

- Material de bronce



FIGURA	MEDIDA	CONT. MTR	PRECIO UNIT.
B94-B	1/2"	100	\$74.86
	3/4"	100	\$123.39

VÁLVULA DE ESFERA

- De C.P.V.C.
- Conexión cementar



FIGURA	MEDIDA	CONT. MTR	PRECIO UNIT.
100-CP	1/2"	500	\$61.29
	3/4"	300	\$90.56
	1"	150	\$157.84

- De P.V.C.
- Conexión roscable



FIGURA	MEDIDA	CONT. MTR	PRECIO UNIT.
100-P	1/2"	200	\$42.87
	3/4"	200	\$61.47
	1"	120	\$99.03
	1 1/4"	64	\$132.88
	1 1/2"	400	\$186.67
	2"	24	\$298.99

Estos precios **NO** incluyen I.V.A.-Esta lista sustituye a las anteriores-Sujetos a cambios sin previo aviso.

La información e imágenes contenidas pueden sufrir cambios sin previo aviso, por motivos de actualización y mejora continua sin responsabilidad alguna por la marca o su publicidad

VÁLVULA DE ESFERA

- Material de latón
- Flujo total
- Cierre 90°
- Roscable



FIGURA	MEDIDA	CONT. MTR	PRECIO UNIT.
100-I	1/4"	180	\$147.12
	3/8"	180	\$180.34
	1/2"	100	\$154.72
	3/4"	120	\$234.13
	1"	60	\$423.96
	1 1/4"	40	\$648.60
	1 1/2"	40	\$990.30
	2"	24	\$1,499.69
	3"	6	\$5,027.45
	4"	4	\$8,385.93

- Material de latón
- Flujo total
- Cierre 90°
- Soldable



FIGURA	MEDIDA	CONT. MTR	PRECIO UNIT.
100-IS	1/2"	120	\$142.77
	3/4"	60	\$225.43
	1"	60	\$420.29
	1 1/2"	30	\$908.04

- De P.V.C.
- Cementar



FIGURA	MEDIDA	CONT. MTR	PRECIO UNIT.
100-PS	1/2"	220	\$39.98
	3/4"	120	\$63.28
	1"	120	\$100.93
	1 1/4"	56	\$132.22
	1 1/2"	40	\$187.30
	2"	24	\$298.99

- Material de latón
- Flujo reducido
- Cierre 90°
- Roscable



FIGURA	MEDIDA	CONT. MTR	PRECIO UNIT.
100-RR	1/2"	180	\$130.00
	3/4"	120	\$195.22
	1"	60	\$318.92
	1 1/2"	40	\$825.78
	2"	24	\$1,249.74

- Material de latón
- Flujo reducido
- Cierre 90°
- Soldable



FIGURA	MEDIDA	CONT. MTR	PRECIO UNIT.
100-SR	1/2"	100	\$129.25
	3/4"	120	\$183.95
	1"	100	\$330.63
	1 1/2"	30	\$854.25
	2"	24	\$1,054.71

- Material de latón
- Flujo total
- Cierre 90°
- Roscable



FIGURA	MEDIDA	CONT. MTR	PRECIO UNIT.
102-IR	1"	108	\$437.96
	1 1/4"	40	\$688.31
	1 1/2"	32	\$1,044.37
	2"	18	\$1,511.81

- Material de latón
- Flujo total
- Cierre 90°
- Soldable



FIGURA	MEDIDA	CONT. MTR	PRECIO UNIT.
102-IS	1/2"	140	\$157.93
	2"	18	\$1,322.31

VÁLVULA DE PICHANCHA

- Material de latón



FIGURA	MEDIDA	CONT. MTR	PRECIO UNIT.
V-PP	1/2"	100	\$164.84
	3/4"	100	\$187.94
	1"	60	\$216.41
	1 1/4"	60	\$345.66
	1 1/2"	50	\$539.45
	2"	40	\$828.94
	3"	12	\$2,527.96

- Material de latón
- Canastilla de acero inoxidable



FIGURA	MEDIDA	CONT. MTR	PRECIO UNIT.
V-PPRF	1/2"	100	\$156.30
	3/4"	100	\$189.12
	1"	50	\$247.31
	1 1/4"	50	\$435.83
	1 1/2"	40	\$595.13
2"	12	\$980.81	

Estos precios **NO** incluyen I.V.A.-Esta lista sustituye a las anteriores-Sujetos a cambios sin previo aviso.

La información e imágenes contenidas pueden sufrir cambios sin previo aviso, por motivos de actualización y mejora continua sin responsabilidad alguna por la marca o su publicidad

COMPLEMENTOS

NIPLE REDUCCIÓN

- Material de bronce



FIGURA	MEDIDA	CONT. MASTER	PRECIO UNITARIO
97-NR	3/4" x 1/2"	500	\$93.59

NIPLE REDUCCIÓN BUSHING

- Material de bronce



FIGURA	MEDIDA	CONT. MASTER	PRECIO UNITARIO
97-RB	3/4" x 1/2"	30	\$93.90

NIPLE UNIÓN

- Material de bronce



FIGURA	MEDIDA	CONT. MASTER	PRECIO UNITARIO
97-N	1/2" x 1/2"	500	\$62.80

TAPÓN MACHO

- Material de bronce



FIGURA	MEDIDA	CONT. MASTER	PRECIO UNITARIO
97-TM	1/2"	500	\$45.88

TAPÓN MACHO

- Material de bronce
- Para prueba hermeticida en toma domiciliaria



FIGURA	MEDIDA	CONT. MASTER	PRECIO UNITARIO
97-TPH	3/4"	250	\$104.92

COPLE UNIÓN DE REPARACIÓN

- Material de bronce



NOM SOLO PARA 1/2", 3/4" Y B81-U

FIGURA	MEDIDA	CONT. MTR	PRECIO UNITARIO
81-U	SISTEMA DE COMPR. 13 mm P/TUBO C/DIÁMETRO EXT .625=5/8"	100	\$192.14
	SISTEMA DE COMPR. 19 mm P/TUBO C/DIÁMETRO EXT .750=3/4"	75	\$296.36
	SISTEMA DE COMPR. 22 mm P/TUBO C/DIÁMETRO EXT .875=7/8"	75	\$296.36
	SISTEMA DE COMPR. 25 mm P/TUBO C/DIÁMETRO EXT .1000=1"	50	\$442.95
B81-U (BOLSAS)	SISTEMA DE COMPR. 13 mm P/TUBO C/DIÁMETRO EXT .625=5/8"	50	\$198.47
	SISTEMA DE COMPR. 22 mm P/TUBO C/DIÁMETRO EXT .875=7/8"	50	\$302.69

- Material de latón



FIGURA	MEDIDA	CONT. MTR	PRECIO UNITARIO
81-UL	SISTEMA DE COMPR. 13 mm P/TUBO C/DIÁMETRO EXT .625=5/8"	96	\$161.36

- Para tubo galvanizado, de cobre, de P.V.C. y de C.P.V.C. de 1/2"



FIGURA	MEDIDA	CONT. MASTER	PRECIO UNITARIO
CRP-1	1/2"	250	\$66.25

Estos precios **NO** incluyen I.V.A.-Esta lista sustituye a las anteriores-Sujetos a cambios sin previo aviso.

La información e imágenes contenidas pueden sufrir cambios sin previo aviso, por motivos de actualización y mejora continua sin responsabilidad alguna por la marca o su publicidad

SPUD

CONTRA TAZA

- Material de bronce
- Con empaque



FIGURA	MEDIDA	CONT. MASTER	PRECIO UNITARIO
65	32 mm 38 mm	50 50	\$322.72 \$344.87

SPUD PARA MINGITORIO

- Material de bronce



FIGURA	MEDIDA	CONT. MTR	PRECIO UNIT.
71	19 mm	100	\$148.78
	32 mm	50	\$243.62
	38 mm	50	\$243.49
	51 mm	50	\$386.00
71-LV	19 mm	100	\$179.29
71-V	38 mm	50	\$303.32

BRIDA MINGITORIO

- Material de bronce



FIGURA	MEDIDA	CONT. MASTER	PRECIO UNITARIO
70	6 1/8"	50	\$360.69

- Material de bronce
- Para mingitorio cato



FIGURA	MEDIDA	CONT. MASTER	PRECIO UNITARIO
70-C	5 7/16"	50	\$344.87

- Material de bronce
- Para mingitorio lamosa



FIGURA	MEDIDA	CONT. MTR	PRECIO UNIT.
70-L	6 1/8"	50	\$344.87

- Material de bronce
- Para mingitorio procemex



FIGURA	MEDIDA	CONT. MTR	PRECIO UNIT.
70-P	4"	50	\$325.88

- Material de bronce
- Para mingitorio vitromex



FIGURA	MEDIDA	CONT. MTR	PRECIO UNIT.
70-V	6 1/8"	50	\$376.50

PEGAMENTOS

- Para C.P.V.C.



FIGURA	CONT. MASTER	PRECIO UNITARIO
CPVC-1	120	\$58.53

- Para C.P.V.C.
- Con aplicador



FIGURA	CONT. NETO	CONT. MASTER	PRECIO UNITARIO
CPVC-2	125 ml	48	\$117.22

- Para P.V.C.



FIGURA	CONT. MASTER	PRECIO UNITARIO
R-60	120	\$48.41

- Para P.V.C.
- Con aplicador



FIGURA	CONT. NETO	CONT. MASTER	PRECIO UNITARIO
R-118	125 ml	48	\$99.03
R-236	250 ml	48	\$135.26
R-473	500 ml	12	\$251.53

Estos precios **NO** incluyen I.V.A.-Esta lista sustituye a las anteriores-Sujetos a cambios sin previo aviso.
La información e imágenes contenidas pueden sufrir cambios sin previo aviso, por motivos de actualización y mejora continua sin responsabilidad alguna por la marca o su publicidad

CHIFLÓN Y CONEXIÓN PARA MANGUERA



CHIFLÓN RECTO

- Material de latón
- Medida de 3"

FIGURA
CH-I

CONT. MASTER
100

PRECIO UNITARIO
\$106.55



CHIFLÓN PISTOLA

- Metálico
- Acabado cromo

FIGURA
CH-P

CONT. MASTER
210

PRECIO UNITARIO
\$138.68



CHIFLÓN PISTOLA

- De plástico

FIGURA
CHP-05

CONT. MASTER
48

PRECIO UNITARIO
\$60.11



CHIFLÓN PISTOLA

- De plástico
- 5 funciones

FIGURA
CHP-10

CONT. MASTER
48

PRECIO UNITARIO
\$89.57



CHIFLÓN PISTOLA

- De plástico
- 8 funciones

FIGURA
CHP-15

CONT. MASTER
48

PRECIO UNITARIO
\$170.85



CONECTOR "Y" DE PLÁSTICO

- Para 2 mangueras

FIGURA
69-RC

CONT. MASTER
240

PRECIO UNITARIO
\$64.62



- Material de latón fundido
- Completa

FIGURA
2-CI

MEDIDA
1/2"
3/4"
5/8"

CONT. MASTER
400
200
200

PRECIO UNITARIO
\$84.16
\$98.89
\$83.86



- Material de latón troquelado
- Completa de 13 mm

FIGURA
2-CL

CONT. MASTER
500

PRECIO UNITARIO
\$85.00



- Material de bronce
- Hembra 13 mm

FIGURA
2-HI

CONT. MASTER
500

PRECIO UNITARIO
\$56.63



- Material de latón troquelado
- Hembra de 13 mm

FIGURA
2-HL

CONT. MASTER
500

PRECIO UNITARIO
\$66.22

Estos precios **NO** incluyen I.V.A.-Esta lista sustituye a las anteriores-Sujetos a cambios sin previo aviso.
La información e imágenes contenidas pueden sufrir cambios sin previo aviso, por motivos de actualización y mejora continua sin responsabilidad alguna por la marca o su publicidad

CONECTORES DE C.P.V.C.

COUPLE



FIGURA	MEDIDA	CONT. MTR	PRECIO UNIT.
C-01	13 mm	2500	\$3.42
	19 mm	1000	\$7.09
	25 mm	500	\$12.02

CODO 90°



FIGURA	MEDIDA	CONT. MTR	PRECIO UNIT.
C-02	13 mm	1600	\$4.43
	19 mm	650	\$8.23
	25 mm	300	\$17.27

TEE



FIGURA	MEDIDA	CONT. MTR	PRECIO UNIT.
C-03	13 mm	1050	\$6.04
	19 mm	400	\$12.88
	25 mm	200	\$20.53

CODO 45°



FIGURA	MEDIDA	CONT. MTR	PRECIO UNIT.
C-04	13 mm	1700	\$4.30
	19 mm	750	\$7.56
	25 mm	350	\$16.42

ADAPTADOR MACHO



FIGURA	MEDIDA	CONT. MTR	PRECIO UNIT.
C-05	13 mm	1700	\$5.73
	19 mm	950	\$9.08
	25 mm	500	\$13.76

ADAPTADOR MACHO



• Rosca de latón

FIGURA	MEDIDA	CONT. MTR	PRECIO UNIT.
C-06	13 mm	325	\$77.52
	19 mm	200	\$118.65
	25 mm	110	\$180.34

REDUCCIÓN BUSHING



FIGURA	MEDIDA	CONT. MTR	PRECIO UNIT.
C-07	19X13 mm	2300	\$4.02
	25X13 mm	1050	\$10.79
	25X19 mm	1050	\$9.74

ADAPTADOR HEMBRA



• Rosca de latón

FIGURA	MEDIDA	CONT. MTR	PRECIO UNIT.
C-09	13 mm	425	\$56.63
	19 mm	260	\$79.03
	25 mm	140	\$160.41

COPELLE REDUCCIÓN



FIGURA	MEDIDA	CONT. MTR	PRECIO UNIT.
C-10	19X13 mm	1300	\$7.63
	25X13 mm	680	\$14.88
	25X19 mm	650	\$17.09

TAPÓN



FIGURA	MEDIDA	CONT. MTR	PRECIO UNIT.
C-12	13 mm	4500	\$2.69
	19 mm	1800	\$4.37
	25 mm	900	\$9.68

TEE REDUCCIÓN



FIGURA	MEDIDA	CONT. MTR	PRECIO UNIT.
C-14	19X13 mm	550	\$12.02
	25X13 mm	300	\$21.93

COPELLE UNIÓN



FIGURA	MEDIDA	CONT. MTR	PRECIO UNIT.
C-17	13 mm	600	\$21.51
	19 mm	360	\$37.81
	25 mm	200	\$59.80

CODO CON OREJAS



FIGURA	MEDIDA	CONT. MTR	PRECIO UNIT.
C-26	13 mm	45	\$21.36

ADAPTADOR HEMBRA



FIGURA	MEDIDA	CONT. MTR	PRECIO UNIT.
C-28	13 mm	1250	\$7.63
	19 mm	700	\$11.07
	25 mm	400	\$18.83

Estos precios **NO** incluyen I.V.A.-Esta lista sustituye a las anteriores-Sujetos a cambios sin previo aviso.

La información e imágenes contenidas pueden sufrir cambios sin previo aviso, por motivos de actualización y mejora continua sin responsabilidad alguna por la marca o su publicidad

ABRAZADERA FLEXÓMETROS

ABRAZADERA DE ACERO INOXIDABLE



FIGURA	MEDIDA	MEDIDA	PRECIO UNIT.
	4	1/4" a 5/8"	\$12.81
	6	1/2" a 3/4"	\$12.81
	8	1/2" a 7/8"	\$15.34
	10	5/8 a 1"	\$18.27
	12	5/8" a 1 1/4"	\$22.09
	16	3/4" a 1 1/2"	\$23.44
	20	3/4" a 1 3/4"	\$22.21
A-I	24	1" a 2"	\$24.12
	28	1 1/2" a 2 1/4"	\$24.59
	36	2" a 2 3/4"	\$24.73
	40	2 1/4" a 3"	\$26.23
	44	2 1/2" a 3 1/4"	\$26.22
	48	2 3/4" a 3 1/2"	\$28.29
	52	3" a 3 3/4"	\$29.47
	60	3 1/2" a 4 1/4"	\$32.94
	72	4" a 5"	\$33.32

FLEXÓMETROS



FIGURA	MEDIDA	CONT. MASTER	PRECIO UNITARIO
FLE-3	3 m.	120	\$151.87
FLE-5	5 m.	120	\$213.28
FLE-8	8 m.	60	\$359.86

CINTAS

CINTA AISLANTE

- Color negro
- Medida 0.13 mm x 19 mm x 18 mts



FIGURA CAN	CONT. MTR	PRECIO UNIT.
	300	\$25.25

CINTA DE ADVERTENCIA

- Color amarilla de precaución
- Medida 0.04 mm x 7 mts



FIGURA CAP-01	CONT. MTR	PRECIO UNIT.
	24	\$336.64

CINTA CANELA

- Color cafe canela
- Medida 0.04 mm x 48 mm x 50 mts



FIGURA	CONT. MTR	PRECIO UNIT.
CC-01	72	\$37.84

MASKING TAPE

- Usos generales



FIGURA	MEDIDA	CONT. MTR	PRECIO UNIT.
CMT-01	13 mm x 50 mts 1/2" x 26	132	\$29.16
CMT-02	18 mm x 50 mts 1/2" x 520	96	\$43.98
CMT-03	24 mm x 50 mts 3/4" x 26	72	\$54.10
CMT-04	36 mm x 50 mts 1" x 520	48	\$85.43
CMT-05	48 mm x 50 mts 1" x 520	36	\$109.71

CINTA ANTI DERRAPANTE

- Color negro
- Medida 0.75 mm x 5 mts



FIGURA	CONT. MTR	PRECIO UNIT.
CNA-01	10	\$249.95

CINTA TRANSPARENTE

- Medida 0.04 mm x 48 mm x 50 mts



FIGURA	CONT. MTR	PRECIO UNIT.
CT-01	72	\$37.57

CINTA DE TEFLÓN

- Color blanco



FIGURA	ACABADO	CONT. MTR	PRECIO UNIT.
CT-I	1/2" X 260	1000	\$6.37
	1/2" X 520	1200	\$15.12
	3/4" X 260"	1000	\$8.93
	1" X 520"	500	\$18.64

Estos precios **NO** incluyen I.V.A.-Esta lista sustituye a las anteriores-Sujetos a cambios sin previo aviso.

La información e imágenes contenidas pueden sufrir cambios sin previo aviso, por motivos de actualización y mejora continua sin responsabilidad alguna por la marca o su publicidad

CERRADURAS



CERRADURA PALANCA

- Material acero inoxidable
- Combo llave / mariposa
- Cilindro de latón

FIGURA CCLM	ACABADO SATINADO	CONT. MASTER 20	PRECIO UNITARIO \$760.11
----------------	---------------------	--------------------	-----------------------------



CERRADURA PARA BAÑO

- Material acero inoxidable
- Con botón
- Tipo esfera
- Cilindro de latón

FIGURA CEB	ACABADO SATINADO	CONT. MASTER 30	PRECIO UNITARIO \$207.39
---------------	---------------------	--------------------	-----------------------------



CERRADURA PALANCA PARA BAÑO

- Material acero inoxidable
- Con botón
- Cilindro de latón

FIGURA CEBP	ACABADO SATINADO	CONT. MASTER 20	PRECIO UNITARIO \$654.65
----------------	---------------------	--------------------	-----------------------------



CERRADURA COMBO CON DOBLE LLAVE

- Material acero inoxidable
- Con botón
- Tipo esfera
- Cilindro de latón

FIGURA CECO	ACABADO SATINADO	CONT. MASTER 20	PRECIO UNITARIO \$618.27
----------------	---------------------	--------------------	-----------------------------



CERROJO

- Material acero inoxidable
- Doble llave y cilindro de latón
- Cilindro de latón

FIGURA CEDL	ACABADO SATINADO	CONT. MASTER 24	PRECIO UNITARIO \$356.42
----------------	---------------------	--------------------	-----------------------------



CERRADURA DE ENTRADA CON LLAVE

- Material acero inoxidable
- Con botón
- Tipo esfera
- Cilindro de latón

FIGURA CEL	ACABADO SATINADO	CONT. MASTER 30	PRECIO UNITARIO \$261.46
---------------	---------------------	--------------------	-----------------------------



CERROJO

- Material acero inoxidable
- Llave mariposa
- Cilindro de latón

FIGURA CELM	ACABADO SATINADO	CONT. MASTER 30	PRECIO UNITARIO \$301.86
----------------	---------------------	--------------------	-----------------------------



CERRADURA PALANCA DE ENTRADA CON LLAVE

- Material acero inoxidable
- Con botón
- Cilindro de latón

FIGURA CELP	ACABADO SATINADO	CONT. MASTER 20	PRECIO UNITARIO \$580.10
----------------	---------------------	--------------------	-----------------------------



CERRADURA DE SOBREPONER

- Tipo parche
- Con llave de latón

FIGURA CEP	CONT. MASTER 30	PRECIO UNITARIO \$480.07
---------------	--------------------	-----------------------------



CERRADURA DE SOBREPONER







- Tipo parche
- Con llave de latón

FIGURA CEPD	CONT. MASTER 30	PRECIO UNITARIO \$480.07
----------------	--------------------	-----------------------------

Estos precios **NO** incluyen I.V.A.-Esta lista sustituye a las anteriores-Sujetos a cambios sin previo aviso.

La información e imágenes contenidas pueden sufrir cambios sin previo aviso, por motivos de actualización y mejora continua sin responsabilidad alguna por la marca o su publicidad

CANDADOS

	<ul style="list-style-type: none"> Laminado Gancho corto 						<ul style="list-style-type: none"> Laminado Gancho corto Hierro sólido 						<ul style="list-style-type: none"> Laminado Gancho largo Hierro Sólido 					
FIGURA 200-L	MEDIDA 30 mm 40 mm 50 mm	CONT. MTR 240 120 96	PRECIO UNIT. \$83.54 \$106.78 \$134.08	FIGURA 210-H	MEDIDA 30 mm 40 mm 50 mm	CONT. MTR 180 120 60	PRECIO UNIT. \$66.44 \$95.58 \$148.96	FIGURA 220-H	MEDIDA 30 mm 40 mm 50 mm	CONT. MTR 180 120 60	PRECIO UNIT. \$72.73 \$98.70 \$161.08							
	<ul style="list-style-type: none"> Laminado Gancho corto 				<ul style="list-style-type: none"> Laminado Gancho corto Hierro sólido 				<ul style="list-style-type: none"> Laminado Gancho largo Hierro Sólido 									
FIGURA B200-L Blister	MEDIDA 30 mm 40 mm 50 mm	CONT. MTR 120 120 96	PRECIO UNIT. \$85.68 \$114.78 \$144.27	FIGURA B210-H Blister	MEDIDA 30 mm 40 mm 50 mm	CONT. MTR 100 100 50	PRECIO UNIT. \$85.98 \$104.19 \$156.39	FIGURA B220-H Blister	MEDIDA 30 mm 40 mm 50 mm	CONT. MTR 100 100 40	PRECIO UNIT. \$90.23 \$129.72 \$163.37							

BOTE DE BASURA Y BRIDA











		<ul style="list-style-type: none"> Color gris 			<ul style="list-style-type: none"> Material de A.B.S. 						
FIGURA BOT-01	CAPACIDAD 23 LITROS		PRECIO UNITARIO \$186.67	FIGURA F-C	ACABADO CROMO	CONT. MASTER 160	PRECIO UNITARIO \$87.17				

REMOVEDOR Y SELLADOR

	<ul style="list-style-type: none"> En aerosol 				<ul style="list-style-type: none"> En aerosol 						
FIGURA FS-01	CONT. NETO 248 g	CONT. MASTER 18	PRECIO UNITARIO \$545.92	FIGURA GOG-03	CONT. NETO 454 g	CONT. MASTER 6	PRECIO UNITARIO \$376.44				
											
FIGURA GOL-01	CONT. NETO 133 ml	CONT. MASTER 6	PRECIO UNITARIO \$188.27	FIGURA GOT-02	CONT. NETO 30 TOALLAS	CONT. MASTER 6	PRECIO UNITARIO \$332.35				

Estos precios **NO** incluyen I.V.A.-Esta lista sustituye a las anteriores-Sujetos a cambios sin previo aviso.
La información e imágenes contenidas pueden sufrir cambios sin previo aviso, por motivos de actualización y mejora continua sin responsabilidad alguna por la marca o su publicidad

REFACCIONES CARTUCHO CERÁMICO

	<ul style="list-style-type: none"> • Para llave temporizadora • Aplica para Fig. 16-T y 69-T 			<ul style="list-style-type: none"> • Para monomando Fig. 34-MC y 34-MS • En blister 	
FIGURA CC-16T	CONT. MASTER 100	PRECIO UNITARIO \$1,500.70	FIGURA R-34MC	CONT. MASTER 200	PRECIO UNITARIO \$174.57
	<ul style="list-style-type: none"> • Para monomando Fig. 34-MQ • En blister 			<ul style="list-style-type: none"> • Para monomando fig. 36-MM, 37-MM, 103-LM, 105-FM, 108-RM • En blister 	
FIGURA R-34MQ	CONT. MASTER 200	PRECIO UNITARIO \$108.38	FIGURA R-36MM	CONT. MASTER 200	PRECIO UNITARIO \$174.57
	<ul style="list-style-type: none"> • Para maneral palanca agua fría • Para llave de empotrar • Para figs. 36-IP, 40-P y 41-P 			<ul style="list-style-type: none"> • Para maneral palanca agua caliente • Para figs. 8-IC, 19-FA, 19-FAS, 19-FCS, 19-I, 19-IB, 19-IBS, 19-ICS, 19-IS, 19-P, 36-AR, 36-CHD, 36-GR, 36-I, 36-ICM, 36-ICR, 36-IHD, 36-IP, 36-IS, 36-ISH, 36-PHF, 36-PM, 36-KHD, 36-MHD, 36-RCC, 38-EC, 38-IC, 39-EC, 39-IC, 40-CR, 40-P, 41-CR, 41-P 	
FIGURA RB-71E	CONT. MASTER 200	PRECIO UNITARIO \$130.93	FIGURA RB-72E	CONT. MASTER 200	PRECIO UNITARIO \$95.71
	<ul style="list-style-type: none"> • Para maneral palanca agua fría • Para figs. 6-LC, 6-LS, 7-LC, 7-LS, 8-IP, 8-IPF, 8-IPP, 8-LC, 8-LS, 8-P, 8-PP, 8-R, 23-IB, 23-PR, 23-RI, 24-BP, 24-IP, 24-P, 24-PP, 24-R, 24-TP 			<ul style="list-style-type: none"> • Para maneral redondo ó cruce-ta agua fría • Para figs. 7-F, 7-FC, 7-FL, 8-CR, 8-CRF, 8-I, 8-IE, 8-ICC 8-IG, 8-IL, 8-RB, 8-RBL, 9-I, 16-B, 16-BL, 19-BA, 19-BCR, 23-CRE, 23-I, 23-IE, 23-IL, 23-IR, 23-RL, 24-CC, 24-I, 24-IB, 24-IBL, 24-IL, 24-T, 24-RM, 24-TL, 24-CRB, 34-I, 35-I 	
FIGURA RB-73F	CONT. MASTER 200	PRECIO UNITARIO \$95.71	FIGURA RB-73L	CONT. MASTER 200	PRECIO UNITARIO \$102.10
	<ul style="list-style-type: none"> • Para maneral palanca agua fría • Para figs. 8-D, 8-DRB, 8-ID, 8-PP, 23-IB, 23-PB, 23-PR, 23-RD, 23-RDG, 23-RI, 24-BP, 24-ID, 24-IGH, 24-IP, 24-P, 24-PB, 24-PP, 24-R, 24-TD, 24-TG, 24-TP, 24-TPA 			<ul style="list-style-type: none"> • Para maneral redondo ó cruce-ta agua fría • Para figs. 8-ICC, 8-IE, 21-PHD, 23-CRE, 23-I, 23-IE, 23CRM, 23-IL, 23-IRR, 23-IR, 23-IRS, 23-MM, 24-CC, 24-CRB, 24-I, 24-IB, 24-IBL, 24-IG, 24-IL, 24-IMM, 24-IR, 24-IS, 24-RM, 24-RMM, 24-T, 24-TAI, 24-TH, 24-TL, 24-TR, 24-TS 	
FIGURA RB-74F	CONT. MASTER 200	PRECIO UNITARIO \$102.10	FIGURA RB-74L	CONT. MASTER 200	PRECIO UNITARIO \$104.23

NUEVO PRODUCTO

NUEVO PRODUCTO

NUEVO PRODUCTO

Estos precios **NO** incluyen I.V.A.-Esta lista sustituye a las anteriores-Sujetos a cambios sin previo aviso.
La información e imágenes contenidas pueden sufrir cambios sin previo aviso, por motivos de actualización y mejora continua sin responsabilidad alguna por la marca o su publicidad

REFACCIONES CARTUCHO CERÁMICO



- Para figs 36-C y 36-THS

FIGURA
RC-36C

CONT. MASTER
200

PRECIO UNITARIO
\$138.21



- Para maneral redondo ó cruceta de agua caliente

FIGURA
RI-36C

CONT. MASTER
200

PRECIO UNITARIO
\$132.88

CARTUCHO WASHARLESS



- Para ensamble 1/2 caña

FIGURA
8R-22

CONT. MASTER
200

PRECIO UNITARIO
\$118.41



- Para ensamble estría

FIGURA
8R-25

CONT. MASTER
200

PRECIO UNITARIO
\$123.39

INSERTO PARA ENSAMBLE



- De estría fina (20 estrías)
- A estría estándar (12 estrías)

FIGURA
RI-41

CONT. MASTER
30

PRECIO UNITARIO
\$12.50



CARTUCHO DE COMPRESIÓN



- Ensamble cuadro
- Para llave de empotrar

FIGURA
98

CONT. MASTER
150

PRECIO UNITARIO
\$105.14



- Ensamble estría
- Para figs. 7-F,7-FC,7-FL,8-IN,16-B,16-BL,32-I, 33-I,34-I,35-I

FIGURA
98-CC

CONT. MASTER
150

PRECIO UNITARIO
\$85.45



- Ensamble cuadro

FIGURA
98-CE

CONT. MASTER
150

PRECIO UNITARIO
\$94.32



- Ensamble estría

FIGURA
98-E





















CONT. MASTER
150

PRECIO UNITARIO
\$95.87



Estos precios **NO** incluyen I.V.A.-Esta lista sustituye a las anteriores-Sujetos a cambios sin previo aviso.
La información e imágenes contenidas pueden sufrir cambios sin previo aviso, por motivos de actualización y mejora continua sin responsabilidad alguna por la marca o su publicidad

CARTUCHO DE REFACCIONES COMPRESIÓN

 <p>FIGURA 98-EE</p>	<ul style="list-style-type: none"> • Ensamble estría <p>CONT. MASTER 150</p> <p>PRECIO UNITARIO \$94.32</p> 	 <ul style="list-style-type: none"> • Ensamble estría • Para figs. 8-Q,8-QL,24-CL,24-CT,24-K,24-KL,24-Q,24-QL <p>CONT. MASTER 150</p> <p>PRECIO UNITARIO \$87.01</p> 
 <p>FIGURA 98-N</p>	<ul style="list-style-type: none"> • Ensamble cuadro • Para figs. 4-B 1/2",66-B,73 1/2", 74-A <p>CONT. MASTER 150</p> <p>PRECIO UNITARIO \$88.59</p> 	 <ul style="list-style-type: none"> • Ensamble cuadro <p>CONT. MASTER 150</p> <p>PRECIO UNITARIO \$84.48</p> 
 <p>FIGURA B98</p>	<ul style="list-style-type: none"> • Ensamble cuadro • Para llave de empotrar <p>BLISTER</p> <p>CONT. MASTER 100</p> <p>PRECIO UNITARIO \$108.36</p> 	 <ul style="list-style-type: none"> • Ensamble estría • Para figs. 7-F,7-FC,7-FL,8-IN,16-B,16-BL,32-I, 33-I,34-I,35-I <p>BLISTER</p> <p>CONT. MASTER 100</p> <p>PRECIO UNITARIO \$103.36</p> 
 <p>FIGURA B98-CE</p>	<ul style="list-style-type: none"> • Ensamble cuadro <p>BLISTER</p> <p>CONT. MASTER 100</p> <p>PRECIO UNITARIO \$107.19</p> 	 <ul style="list-style-type: none"> • Ensamble estría <p>BLISTER</p> <p>CONT. MASTER 100</p> <p>PRECIO UNITARIO \$106.05</p> 
 <p>FIGURA B98-EE</p>	<ul style="list-style-type: none"> • Ensamble estría <p>BLISTER</p> <p>CONT. MASTER 100</p> <p>PRECIO UNITARIO \$100.99</p> 	 <ul style="list-style-type: none"> • Ensamble estría • Para figs. 8-Q,8-QL,24-CL,24-CT,24-K,24-KL,24-Q,24-QL <p>BLISTER</p> <p>CONT. MASTER 100</p> <p>PRECIO UNITARIO \$97.01</p> 

Estos precios **NO** incluyen I.V.A.-Esta lista sustituye a las anteriores-Sujetos a cambios sin previo aviso.
La información e imágenes contenidas pueden sufrir cambios sin previo aviso, por motivos de actualización y mejora continua sin responsabilidad alguna por la marca o su publicidad

REFACCIONES CARTUCHO DE COMPRESIÓN



- Ensamble cuadro
- Para figs. 4-B 1/2", 66-B, 73 1/2", 74-A



FIGURA B98-N

BLISTER

CONT. MASTER
100

PRECIO UNITARIO
\$93.49



- Ensamble cuadro



FIGURA B98-RC

BLISTER

CONT. MASTER
100

PRECIO UNITARIO
\$94.28



- Compatible con cartucho cerámico RB-72E
- Ensamble estría
- Para figs. 8-IC, 36-I, 36-ICR, 36-IS, 36-PM, 36-R, 36-RCI, 36-RF, 38-EC, 38-I, 38-IC, 39-EC, 39-I, 39-IC, 40-CR, 40-E, 41-CR, 41-E



FIGURA BRI-02

BLISTER

CONT. MASTER
100

PRECIO UNITARIO
\$129.04



- Ensamble estría



FIGURA BRI-14

BLISTER

CONT. MASTER
100

PRECIO UNITARIO
\$108.38



- Ensamble estría



FIGURA BRI-98

BLISTER

CONT. MASTER
50

PRECIO UNITARIO
\$273.04



- Ensamble estría
- Para fig. 36-PF



FIGURA R-36PF

CONT. MASTER
102

PRECIO UNITARIO
\$532.14



- Compatible con cartucho cerámico RB-72E
- Ensamble estría
- Para figs. 8-IC, 36-I, 36-ICR, 36-IS, 36-PM, 36-R, 36-RCI, 36-RF, 38-EC, 38-I, 38-IC, 39-EC, 39-I, 39-IC, 40-E, 40-CR, 41-CR, 41-E



FIGURA RI-02

CONT. MTR
50

P. UNIT.
\$120.02



- Ensamble estría



FIGURA RI-14

CONT. MTR
180

P. UNIT.
\$101.11



- Ensamble estría



FIGURA RI-98

CONT. MTR
180

P. UNIT.
\$252.48

PICOS FREGADERO



- Material de acero inoxidable
- Para figs. 7-F, 7-FC, 7-FL



FIGURA 7R-01

ACABADO CROMO

CONT. MASTER
X

PRECIO UNITARIO
\$136.05



- Material de acero inoxidable
- Para figs. 8-BM, 8-RB, 8-RBL



FIGURA 8B-02

ACABADO CROMO

CONT. MASTER
50

PRECIO UNITARIO
\$212.71

Estos precios **NO** incluyen I.V.A.-Esta lista sustituye a las anteriores-Sujetos a cambios sin previo aviso.

La información e imágenes contenidas pueden sufrir cambios sin previo aviso, por motivos de actualización y mejora continua sin responsabilidad alguna por la marca o su publicidad

REFACCIONES PICOS FREGADERO



- Material de acero inoxidable
- Para figs. 8-IC



- Material de acero inoxidable
- Para figs. 8-CR, 8-D, 8-I, 8-IE, 8-IGN, 8-IL, 8-IM, 8-IN, 8-IR, 8-IS, 8-P, 8-PP, 8-R

FIGURA	ACABADO	CONT. MASTER	PRECIO UNITARIO	FIGURA	ACABADO	CONT. MASTER	PRECIO UNITARIO
8C-02	CROMO	100	\$155.03	8R-02	CROMO	100	\$142.38



- Material de acero inoxidable
- Para figs. 8-ICC, 8-ID, 8-IG, 8-IP, 8-IPP



- Material de acero inoxidable
- Para figs. 8-CR, 8-CRF, 8-I, 8-IE, 8-IL, 8-IN, 8-IPF, 8-P, 8-PP, 8-R
- Dos funciones

FIGURA	ACABADO	CONT. MASTER	PRECIO UNITARIO	FIGURA	ACABADO	CONT. MASTER	PRECIO UNITARIO
8R-12	CROMO	100	\$205.89	8R-40	CROMO	50	\$560.05



- Material de acero inoxidable
- Para figs. 8-Q, 8-QL

FIGURA	ACABADO	CONT. MASTER	PRECIO UNITARIO
R-5	CROMO	75	\$150.29

PICOS LAVABO



- Material de acero inoxidable
- Para figs. 24-CL, 24-CT



- Material de acero inoxidable
- Para figs. 24-BP, 24-CC, 24-CRB, 24-CS, 24-IB, 24-IBL, 24-ID, 24-IG, 24-IP, 24-IR, 24-IS

FIGURA	ACABADO	CONT. MASTER	PRECIO UNITARIO	FIGURA	ACABADO	CONT. MASTER	PRECIO UNITARIO
24R-01	CROMO	X	\$113.90	RI-69	CROMO	200	\$135.26











- Material de acero inoxidable
- Para figs. 24-PB, 24-PH, 24-PP, 24-T, 24-TD, 24-TH, 24-TL, 24-TP

FIGURA	ACABADO	CONT. MASTER	PRECIO UNITARIO
RP-24T	CROMO	X	\$123.39



Estos precios **NO** incluyen I.V.A.-Esta lista sustituye a las anteriores-Sujetos a cambios sin previo aviso.
La información e imágenes contenidas pueden sufrir cambios sin previo aviso, por motivos de actualización y mejora continua sin responsabilidad alguna por la marca o su publicidad

REFACCIONES TORNILLOS

 FIGURA R-22	ACABADO CROMO	CONT. MASTER 100	PRECIO UNITARIO \$6.26	 FIGURA RC-01	ACABADO CROMO	CONT. MASTER 100	PRECIO UNITARIO \$5.70
<ul style="list-style-type: none"> • Para resumidero redondo • Medida 5/32" x 3/8" 				<ul style="list-style-type: none"> • Para maneral de figs. 4, 66, B-4, B-66 			
 FIGURA RC-11	ACABADO SIN PULIR	CONT. MASTER 100	PRECIO UNITARIO \$4.11	 FIGURA RE-01	MEDIDA 5/32"X3/42" 5/32"X5/8"	ACABADO CROMO CROMO	CONT. MASTER 100 100 PRECIO UNITARIO \$9.55 \$9.55
<ul style="list-style-type: none"> • Para empaque de árbol • Medida 5/32" x 7/16" 				<ul style="list-style-type: none"> • Para maneral acuario 			
 FIGURA RE-03	ACABADO CROMO	CONT. MASTER 100	PRECIO UNITARIO \$8.61	 FIGURA RI-38	ACABADO CROMO	CONT. MASTER 100	PRECIO UNITARIO \$16.58
<ul style="list-style-type: none"> • Para maneral cuadrado • Medida 5/32" x 5/16" • Para fig. RC-05 				<ul style="list-style-type: none"> • Para maneral grande importado • Medida 5/32" x 3/4" • Para fig. 38-I 			
 FIGURA RL-01	ACABADO CROMO	CONT. MASTER 100	PRECIO UNITARIO \$8.13	 FIGURA RTI-21	ACABADO CROMO	CONT. MASTER 100	PRECIO UNITARIO \$9.09
<ul style="list-style-type: none"> • Para maneral regio • Medida 5/32" x 13/16" 				<ul style="list-style-type: none"> • Para maneral de figs. 24-CT, 24-IB, 24-IBL, 24-K, 16-B, 23-I Y 23-IE • Medida 10/32" x 1/2" 			
 FIGURA 8R-01P	ACABADO CROMO	CONT. MASTER 100	PRECIO UNITARIO \$16.93	 FIGURA 8R-11	ACABADO CROMO	CONT. MASTER 100	PRECIO UNITARIO \$16.93
AIREADOR DE A.B.S. <ul style="list-style-type: none"> • Para mezcladora 8-I • Rosca interior 				AIREADOR DE A.B.S. <ul style="list-style-type: none"> • Para mezcladora 8-IP • Rosca exterior 			

Estos precios **NO** incluyen I.V.A.-Esta lista sustituye a las anteriores-Sujetos a cambios sin previo aviso.

La información e imágenes contenidas pueden sufrir cambios sin previo aviso, por motivos de actualización y mejora continua sin responsabilidad alguna por la marca o su publicidad

REFACCIONES DISPOSITIVOS

AIREADOR



- Ahorrador
- Para mezcladora de fregadero

FIGURA
AMF

CONT. MASTER
250

PRECIO UNITARIO
\$137.82



- Ahorrador
- Fig. PPQ para mezcladoras de lavabo, pico fijo
- Fig PPLLJ para llaves de jardín de 1/2"

FIGURA
PPQ
PPLLJ

CONT. MASTER
100
100

PRECIO UNITARIO
\$149.11
\$149.11

ASIENTOS CAMBIABLES



- Material de bronce
- Para fig. 36-I

FIGURA
ME-03

CONT. MTR
100

PRECIO UNIT.
\$56.95



- Material de latón
- Para llaves de empotrar antigua

FIGURA
RE-10

MEDIDA
CORTO

CONT. MTR
20

P. UNIT.
\$32.56



- Material de celcón
- Para llaves de empotrar antigua

FIGURA
RE-11

PRODUCTO
CORTO

CONT. MTR
20

P. UNIT.
\$16.42



- Material de latón
- Para llaves de empotrar antigua

FIGURA
RE-16

PRODUCTO
LARGO

CONT. MTR
20

P. UNIT.
\$45.88



- Material de celcón
- Para llaves de empotrar antigua

FIGURA
RE-17

PRODUCTO
LARGO

CONT. MTR
20

P. UNIT.
\$19.14



- Material de bronce
- Para fig. 38-Q, 39-Q

FIGURA
RE-20

CONT. MTR
20

PRECIO UNIT.
\$22.21

MANERALES

- Desmontable
- Material de bronce
- Para fig. 2-D



FIGURA
BR-1
R-1

CONT. MASTER
20
20

PRECIO UNITARIO
\$47.14
\$47.46



CACAHUATE

- Para llaves de jardín
- Para válvulas



FIGURA
RC-03
RC-04

CON CUADRO
CON ESTRÍA

CONT. MASTER
2000
1000

PRECIO UNITARIO
\$14.24
\$14.24



CACAHUATE

- Con cuadro
- Para fig. 1



FIGURA
RC-05

ACABADO
CROMO

CONT. MASTER
1000

PRECIO UNITARIO
\$22.84

Estos precios **NO** incluyen I.V.A.-Esta lista sustituye a las anteriores-Sujetos a cambios sin previo aviso.
La información e imágenes contenidas pueden sufrir cambios sin previo aviso, por motivos de actualización y mejora continua sin responsabilidad alguna por la marca o su publicidad

REFACCIONES EMPAQUES



- Oring para pico mezcladora
- Para fig. 8-I
- Contenido 4 piezas



- Para caja de árbol
- Para figs. 1-A, 2-A, 2-D, 2-R, 3, 4
- Contenido 4 piezas



FIGURA
B8R-05

CONT. MASTER
100

PRECIO UNITARIO
\$14.93

FIGURA
BRC-10

CONT. MASTER
100

PRECIO UNITARIO
\$28.53



- Material de nitrilo
- Para figs. 39-I, (RI-02) 9-16" Ø



- Para contra canasta
- Modelo antiguo de 38 mm
- Para fig. 11-B



FIGURA
IE-39I

CONT. MASTER
X

PRECIO UNITARIO
\$3.71

FIGURA
R-05

CONT. MASTER
X

PRECIO UNITARIO
\$6.17



- Material de hule
- Para codo de W.C.
- Para fig. R-15



- Para gozne de regaderas



FIGURA
R-16

CONT. MASTER
X

PRECIO UNITARIO
\$11.86

FIGURA
R-20

CONT. MASTER
X

PRECIO UNITARIO
\$11.11



- Para figs. 52, 72 de 51 mm



- Para cachuca
- Para figs. 1-A, 2-A, 2-R, 3, 4, 69



FIGURA
RB-03

CONT. MASTER
20

PRECIO UNITARIO
\$14.36

FIGURA
RC-08

CONT. MASTER
100

PRECIO UNITARIO
\$4.68



- Para árbol 1/2"Ø de nitrilo
- Para figs. 1-A, 2-A, 2-D, 2-R, 3, 4



- Para bonete de cartucho
- Para fig. 98



FIGURA
RC-10

CONT. MASTER
100

PRECIO UNITARIO
\$4.37

FIGURA
RE-08

CONT. MASTER
100

PRECIO UNITARIO
\$3.12

Estos precios **NO** incluyen I.V.A.-Esta lista sustituye a las anteriores-Sujetos a cambios sin previo aviso.
La información e imágenes contenidas pueden sufrir cambios sin previo aviso, por motivos de actualización y mejora continua sin responsabilidad alguna por la marca o su publicidad

REFACCIONES EMPAQUES

- Para figs. 16-R, 19-IC, 24-CL, 24-CT, 24-K, 24-KL, 24-Q



FIGURA
RE-09

CONT. MASTER
100

PRECIO UNITARIO
\$3.48

- Para cartucho figs. 98-CE, 98-EE, 98-IN



FIGURA
RE-18

CONT. MASTER
100

PRECIO UNITARIO
\$3.28

- Contra canasta con ceja
- Para figs. 12-IL, 13-IL
- Medida de 38 mm



FIGURA
RF-05

CONT. MASTER
2000

PRECIO UNITARIO
\$10.25

- Para mezcladoras 3/8"
- Sello espiga cónico



FIGURA
RL-08

CONT. MASTER
100

PRECIO UNITARIO
\$3.86

- Para figs. 11-B, 12-IL, 13-IL de 38 mm



FIGURA
RR-02

CONT. MASTER
20

PRECIO UNITARIO
\$11.67

- De hule
- Para figs. 29-B de 32 mm



FIGURA
RT-08

CONT. MASTER
20

PRECIO UNITARIO
\$10.16

MANGUERAS

- Para mezcladora de fregadero
- Para fig. 8-ST



FIGURA
RM-8ST

ACABADO
CROMO

CONT. MASTER
60

PRECIO UNITARIO
\$313.23

- Para regadera de teléfono



FIGURA
RI-49

ACABADO
CROMO

CONT. MASTER
50

PRECIO UNITARIO
\$232.77

PALANCA PARA FLOTADOR MANGUERA

- Material de latón
- Para fig. 93



FIGURA
RF-03

ACABADO
SIN PULIR

CONT. MASTER
20

PRECIO UNITARIO
\$43.03

- Material de latón
- Para fig. 93
- Con rosca para varilla



FIGURA
RV-01

ACABADO
SIN PULIR

CONT. MASTER
20

PRECIO UNITARIO
\$36.45

Estos precios **NO** incluyen I.V.A.-Esta lista sustituye a las anteriores-Sujetos a cambios sin previo aviso.
La información e imágenes contenidas pueden sufrir cambios sin previo aviso, por motivos de actualización y mejora continua sin responsabilidad alguna por la marca o su publicidad

REFACCIONES TUERCAS

- Para pico 8-I metálico



FIGURA 8R-03 ACABADO CROMO CONT. MTR 600 PRECIO UNIT. \$37.97

- Para fig. 9-I



FIGURA 9R-13 ACABADO CROMO CONT. MTR X PRECIO UNIT. \$52.55

- Para ajuste de mezcladora (2 c/u RL-07, RL-06)
- Material de bronce



FIGURA BRM-L1 ACABADO SIN PULIR CONT. MTR 100 PRECIO UNIT. \$115.87



- Para fig. 34-MC



FIGURA C34MC ACABADO CROMO CONT. MASTER 100 PRECIO UNITARIO \$69.61

- Para mezcladora 8-K



FIGURA R-7 ACABADO CROMO CONT. MASTER X PRECIO UNITARIO \$48.66



- Para codo W.C. en aluminio y/o P.V.C. 2" de 51 mm
- Material de bronce



FIGURA R-15 ACABADO CROMO CONT. MASTER 300 PRECIO UNITARIO \$148.70



- Cachucha para fig. 5-A, 5-C, 5-CQ
- Material bronce



FIGURA RC-06 ACABADO SIN PULIR CONT. MASTER 20 PRECIO UNITARIO \$26.04
RC-07 CROMO 20 \$53.60



- Para contra canasta 13-IL plana 4"
- Material metálico



FIGURA RF-04 ACABADO CROMO CONT. MASTER 250 PRECIO UNITARIO \$80.68



- Para fig. 11-B, 12-IL, 13-IL de 38 mm
- Material metálico



FIGURA RF-07 ACABADO CROMO CONT. MASTER 500 PRECIO UNITARIO \$52.17



- Para mezcladoras de ajuste
- Material bronce



FIGURA RL-07 ACABADO SIN PULIR CONT. MASTER 1000 PRECIO UNITARIO \$45.05



- Para mezcladora de ajuste
- Material de A.B.S.
- Color negro



FIGURA RL-07P ACABADO NEGRO CONT. MASTER 4000 PRECIO UNITARIO \$10.25



Estos precios **NO** incluyen I.V.A.-Esta lista sustituye a las anteriores-Sujetos a cambios sin previo aviso.

La información e imágenes contenidas pueden sufrir cambios sin previo aviso, por motivos de actualización y mejora continua sin responsabilidad alguna por la marca o su publicidad

REFACCIONES TUERCAS



- Plana, ajuste rosca fina
- Medida 32 mm
- Material de bronce
- Para fig. 29-B



- De ajuste para cartucho
- Para fig. 34-M
- Material de latón



FIGURA
RT-03

ACABADO
SIN PULIR

CONT. MASTER
20

PRECIO UNITARIO
\$65.56

FIGURA
T-34MC

ACABADO
SIN PULIR

CONT. MASTER
50

PRECIO UNITARIO
\$170.85

CHAPETONES

- Para fig. 24-MC
- Material de acero inoxidable



FIGURA
C24-MC

ACABADO
CROMO

CONT. MASTER
120

PRECIO UNITARIO
\$214.54



- Para mezcladora monomando fig 34-MQ
- Material de latón



- Para mezcladora monomando fig. 37-MM
- Material de latón

FIGURA
CH-34M

ACABADO
CROMO

CONT. MASTER
50

PRECIO UNITARIO
\$352.21

FIGURA
CH-37M

ACABADO
CROMO

CONT. MASTER
120

PRECIO UNITARIO
\$306.27



- Para regadera
- Material de acero inoxidable



- Para regadera
- Material de acero inoxidable



FIGURA
CHR

ACABADO
LATÓN

CONT. MASTER
700

PRECIO UNITARIO
\$158.20

FIGURA
CHRC

ACABADO
CROMO

CONT. MASTER
X

PRECIO UNITARIO
\$20.12



- Para fig. 5-A, 5-C
- Material de acero inoxidable



FIGURA
R-2























ACABADO
CROMO

CONT. MASTER
X

PRECIO UNITARIO
\$21.83

Estos precios **NO** incluyen I.V.A.-Esta lista sustituye a las anteriores-Sujetos a cambios sin previo aviso.
La información e imágenes contenidas pueden sufrir cambios sin previo aviso, por motivos de actualización y mejora continua sin responsabilidad alguna por la marca o su publicidad

REFACCIONES VARIOS

<p>TAPA</p> <ul style="list-style-type: none"> Material de acero inoxidable Para fig. 47, 47-CZ  <p>FIGURA CONT. MTR PRECIO UNIT. BR-14 BOLSA 20 \$44.80</p> 	<p>REPUESTO P/MEZCLADORA</p> <ul style="list-style-type: none"> Para fig. 8-I : 8R-03 (1 pieza) 8R-04 (1 pieza) 8R-15 (2 piezas)  <p>FIGURA CONT. MTR PRECIO UNIT. BRM-F1 100 \$41.92</p>	<p>REPUESTO WASHERLESS</p> <ul style="list-style-type: none"> 8R-22 (1 c/u) 8R-23 8R-24 (2 c/u)  <p>FIGURA CONT. MTR PRECIO UNIT. BRM-F3 100 \$237.36</p>	
<p>EXTENSION DE A.B.S.</p> <ul style="list-style-type: none"> Para chapetón fig 36-PF  <p>FIGURA CONT. MTR PRECIO UNIT. E-36PF 2500 \$23.25</p>	<p>ÁRBOL SOLO</p> <ul style="list-style-type: none"> Material de latón  <p>FIGURA CONT. MTR PRECIO UNIT. RC-09 600 \$47.70</p>	<p>TAPA</p> <ul style="list-style-type: none"> Material de acero inoxidable Para fig. 47, 47-CZ  <p>FIGURA CONT. MTR PRECIO UNIT. R-14 250 \$39.52</p> 	
<p>CAMPANA</p> <ul style="list-style-type: none"> Para mingitorio Para fig. 69  <p>FIGURA ACABADO CONT. MTR PRECIO UNIT. R-17 CROMO 100 \$140.79</p>	<p>SIST. ANTI CUCARACHAS</p> <ul style="list-style-type: none"> Para figs. 47-C, 47-CZ  <p>FIGURA CONT. MTR PRECIO UNIT. R-47CZ 500 \$38.41</p> 	<p>TUBO REBOSADERO</p> <ul style="list-style-type: none"> Material de latón Medida de 25 mm Para fig. 52  <p>FIGURA CONT. MTR PRECIO UNIT. RB-02 20 \$139.21</p> 	
<p>TAPA DE ACRÍLICO</p> <ul style="list-style-type: none"> Para maneral de acrílico  <p>FIGURA PRODUCT. CONT. MTR PRECIO UNIT. RI-21 FRIA 50 \$14.36 RI-22 CALIENTE 50 \$14.36</p>	<p>VARILLA ORC</p> <ul style="list-style-type: none"> Para desagüe automático  <p>FIGURA CONT. MTR PRECIO UNIT. RI-28 50 \$434.21</p>	<p>CONTROL</p> <ul style="list-style-type: none"> Para regadera de teléfono  <p>FIGURA ACABADO CONT. MTR PRECIO UNIT. RI-29 CROMO 200 \$145.22</p>	
<p>TAPÓN</p> <ul style="list-style-type: none"> Material de latón Para desagüe de push Para fig. 22-IP  <p>FIGURA ACABADO CONT. MTR PRECIO UNIT. RI-30 CROMO 100 \$287.92</p>	<p>HERRAJE GRANDE</p> <ul style="list-style-type: none"> Para juego de accesorios JE-32C, J32CC  <p>FIGURA ACABADO CONT. MTR PRECIO UNIT. RI-64 CROMO 150 \$101.88</p> 	<p>ARAÑA</p> <ul style="list-style-type: none"> Para ajustes de mezcladora de lavabo y/o fregadero  <p>FIGURA ACABADO CONT. MTR PRECIO UNIT. RL-06 CROMO 20 \$6.14</p> 	
<p>TUBO</p> <ul style="list-style-type: none"> Material de latón Medida de 38 mm Para figs. 12-I, 13-I  <p>FIGURA ACABADO CONT. MTR PRECIO UNIT. RR-04 CROMO 20 \$155.03</p> 		<p>TUBO</p> <ul style="list-style-type: none"> Material de latón Tubo de rosca de 32 mm Para contra fundida de latón Para figs. 30, 30-T  <p>FIGURA ACABADO CONT. MTR PRECIO UNIT. RT-05 CROMO 10 \$142.38</p> 	

Estos precios **NO** incluyen I.V.A.-Esta lista sustituye a las anteriores-Sujetos a cambios sin previo aviso.

La información e imágenes contenidas pueden sufrir cambios sin previo aviso, por motivos de actualización y mejora continua sin responsabilidad alguna por la marca o su publicidad

**CARTUCHO CERÁMICO
MODELO ACTUAL
FIG. 8-I**



DESCRIPCIÓN	FIG.	PRECIO
1.- AIREADOR DE LATÓN	8R-01	\$ 56.86
2.- PICO COMPLETO	8R-02	\$ 142.38
3.- TUERCA P/PICO	8R-03	\$ 37.97
4.- TUERCA AJUSTE CUBIERTA	8R-06	\$ 8.23
5.- CUBIERTA DE MEZCLADORA	N/D*	
6.- CANDADO	8R-04	\$ 7.25
7.- EMPAQUE ORING	8R-05	\$ 4.21
8.- EMPAQUE P/AJUSTE	N/D*	
9.- TUERCA PLANA P/AJUSTE DE A.B.S.	RL-07P	\$ 10.25
9.- TUERCA PLANA P/AJUSTE DE BRONCE	RL-07	\$ 45.05
10.- JGO. DE MANERALES ACUARIO CHICO C/ESTRÍA	RL-12	\$ 129.72
11.- CARTUCHO COMPLETO	RB-73L	\$ 97.26
12.- EMPAQUE #71 BASE MEZCLADORA DE 8"	N/D*	
13.- TORNILLO 10/32" X 1/2" P/ MANERAL C/ESTRÍAS	RTI-21	\$ 9.09
14.- CUERPO MEZCLADORA	N/D*	

**CARTUCHO CERÁMICO
MODELO ACTUAL
FIG. 8-IP**

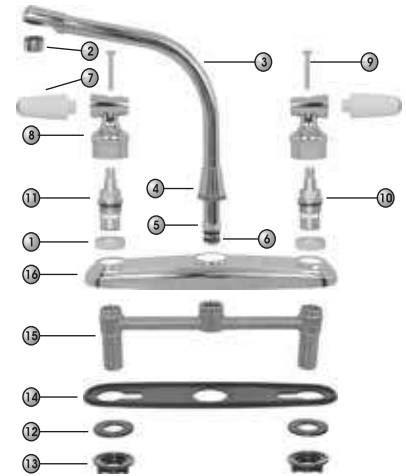

DESCRIPCIÓN	FIG.	PRECIO
1.- TUERCA AJUSTE CUBIERTA	8R-06	\$ 8.23
2.- AIREADOR DE A.B.S.	8R-11	\$ 16.93
3.- PICO COMPLETO	8R-12	\$ 205.89
4.- TUERCA P/PICO	8R-13	\$ 77.52
5.- CANDADO	8R-14	\$ 8.61
6.- EMPAQUE ORING	8R-15	\$ 7.44
7.- JGO. MANERAL PIRULI BLANCO	8R-17	\$ 60.89
8.- JGO. BASE DE MANERAL	8R-20E	\$ 221.28
9.- TORNILLO P/MANERAL 3/16" X 1 1/8"	8R-30	\$ 14.55
10.- CARTUCHO 20 ESTRÍAS (AGUA FRÍA)	RB-73F	\$ 95.71
11.- CARTUCHO 20 ESTRÍAS (AGUA CALIENTE)	RB-73C	\$ 95.71
12.- EMPAQUE P/AJUSTE	N/D*	
13.- TUERCA A.B.S. P/AJUSTE	RL-07P	\$ 10.25
(COMPATIBLE CON RL-07 Y RL-07P)		
14.- EMPAQUE BASE MEZCLADORA DE 8"	N/D*	
15.- CUERPO MEZCLADORA	N/D*	
16.- CUBIERTA MEZCLADORA	N/D*	

FIG. 24-Q



DESCRIPCIÓN	FIG.	PRECIO
1.- PICO COMPLETO	N/D*	
2.- DIFUSOR	N/D*	
3.- TORNILLO 5/32" X 13/16" JGO. MANERAL TAURO CHICO	RE-01	\$ 9.55
4.- INSERTO LARGO	RL-30	\$ 109.11
5.- CARTUCHO COMPLETO E/ CUADRO	98-N	\$ 88.59
6.- EMPAQUE P/PICO	N/D*	
7.- CUBIERTA MEZCLADORA	N/D*	
8.- EMPAQUE P/CUERPO	N/D*	
9.- CUERPO MEZCLADORA	N/D*	
10.- EMPAQUE BASE MEZCLADORA	N/D*	
11.- AÑARA P/AJUSTE	RL-06	\$ 6.14
12.- TUERCA PLANA P/AJUSTE DE A.B.S.	RL-07P	\$ 10.25
12.- TUERCA PLANA P/AJUSTE DE BRONCE	RL-07	\$ 45.05

FIG. 24-IP

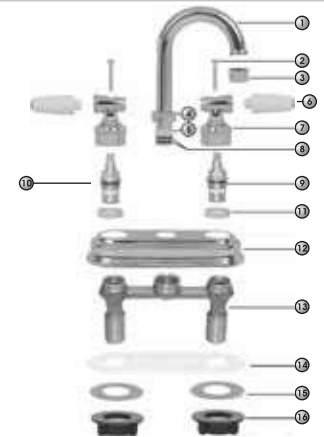

DESCRIPCIÓN	FIG.	PRECIO
1.- PICO COMPLETO	RI-69	\$ 135.26
2.- TORNILLO P/MANERAL 3/16" X 1 1/8"	8R-30	\$ 14.55
3.- AIREADOR DE LATÓN	8R-01	\$ 56.86
4.- TUERCA P/PICO	8R-03	\$ 37.97
5.- CANDADO	8R-04	\$ 7.25
6.- JGO. MANERAL PIRULI BLANCO	8R-17	\$ 60.89
7.- JGO. BASE MANERAL	8R-20E	\$ 221.28
8.- EMPAQUE ORING	8R-15	\$ 7.44
9.- CART. CERÁMICO E/20 ESTRÍAS EN BLISTER (AGUA FRÍA)	RB73F	\$ 95.71
10.- CART. CERÁMICO E/20 ESTRÍAS EN BLISTER (AGUA CALIENTE)	RB73C	\$ 95.71
11.- TUERCA AJUSTE CUBIERTA	8R-06	\$ 8.23
12.- CUBIERTA MEZCLADORA	N/D*	
13.- CUERPO MEZCLADORA	N/D*	
14.- EMPAQUE BASE MEZCLADORA	IE-108	N/D
15.- ARAÑA P/AJUSTE	RL-06	\$ 6.14
16.- TUERCA PLANA P/AJUSTE DE A.B.S.	RL-07P	\$ 10.25
16.- TUERCA PLANA P/AJUSTE DE BRONCE	RL-07	\$ 45.05

* NO DISPONIBLE

Estos precios **NO** incluyen I.V.A.-Esta lista sustituye a las anteriores-Sujetos a cambios sin previo aviso.

La información e imágenes contenidas pueden sufrir cambios sin previo aviso, por motivos de actualización y mejora continua sin responsabilidad alguna por la marca o su publicidad



• Monomando fregadero



FIGURA PMF1 PRECIO UNITARIO \$223.18

• Mezcladora fregadero



FIGURA PMF3 PRECIO UNITARIO \$290.57

• Monomando lavabo



FIGURA PML1 PRECIO UNITARIO \$223.18

• Mezcladora lavabo



FIGURA PML3 PRECIO UNITARIO \$290.57

• Regadera



FIGURA PREG1 PRECIO UNITARIO \$195.24

Estos precios **NO** incluyen I.V.A.-Esta lista sustituye a las anteriores-Sujetos a cambios sin previo aviso.
La información e imágenes contenidas pueden sufrir cambios sin previo aviso, por motivos de actualización y mejora continua sin responsabilidad alguna por la marca o su publicidad

EX-I

(0.70 X 1.75 M)



*IMAGEN REPRESENTATIVA

INCLUYE

- | | |
|-------------------|------------|
| 10-PPF | 44-T |
| 100-I 1/2" | 44-WG |
| 100-P 3/4" | 45-BAI |
| 2-I 1/2" | 45-BC |
| 23-IR | 45-BRA |
| 24-CC | 45-CF |
| 24-IP | 46-AF |
| 24-MC | 46-AR |
| 24-T | 47-CZ |
| 24-TH | 50-P |
| 25 | 52-P |
| 25-E | 75 AH 3/4" |
| 25ME 1/2"x1/2"x40 | 79 3/4" |
| 40-E | 8-IE |
| 41-E | 8-T |
| 44-AR | 93 1/2" |
| 44-F | CHME |
| 44-GP | MCME |
| 44-N | MCRE |
| 44-PH | |

PRECIO

COTIZAR

DISPOIBLE EN CEREZO-OYAMEL

EX-II

(1.0 X 1.75 M)



*IMAGEN REPRESENTATIVA

INCLUYE

- | | |
|--------|--------|
| 109-FM | 44-WG |
| 23-IR | 45-BA |
| 23-MTC | 45-BC |
| 23-MTL | 45-BRA |
| 24-CC | 45-CF |
| 24-IP | 46-AF |
| 24-MC | 46-AR |
| 24-MTL | 47-CZ |
| 24-T | 47-PRB |
| 24-TH | 7-MC |
| 34-MCO | 8-CR |
| 40-E | 8-IE |
| 41-E | 8-IP |
| 44-AM | 8-R |
| 45-BAI | CHME |
| 44-AR | MCRE |
| 44-F | MCME |
| 44-GP | |
| 44-N | |
| 44-PH | |
| 44-T | |

PRECIO

COTIZAR

DISPOIBLE EN CEREZO-OYAMEL

EX-III

(0.70 X 1.75 M)



*IMAGEN REPRESENTATIVA

INCLUYE

- | | |
|--------|-------|
| 23-IR | 46-AR |
| 23-MTC | 47-CZ |
| 23-MTL | 7-MC |
| 24-CC | 8-CR |
| 24-CRB | 8-IE |
| 24-T | 8-IP |
| 24-IP | CHME |
| 24-MC | MCME |
| 24-MTL | MCRE |
| 24-TH | |
| 34-MCO | |
| 44-AR | |
| 44-GP | |
| 44-PH | |
| 44-T | |
| 44-WG | |
| 45-BAI | |
| 45-BC | |
| 45-BRA | |
| 46-AF | |

PRECIO

COTIZAR

DISPOIBLE EN CEREZO-OYAMEL

EX-MA2

(0.65 X 2.20 M)



*IMAGEN REPRESENTATIVA

INCLUYE

- | | |
|--------|------|
| 23-CRE | MCME |
| 23-MTL | MCRG |
| 23-RD | MCSG |
| 24-BT | |
| 24-IP | |
| 24-MC | |
| 44-AP | |
| 44-AR | |
| 44-CA | |
| 44-F | |
| 44-TRC | |
| 45 | |
| 7-MC | |
| 8-BT | |
| 8-CR | |
| 8-D | |
| 8-IC | |
| 8-IP | |
| CHTEE | |

PRECIO

COTIZAR

DISPOIBLE EN CEREZO-OYAMEL

Estos precios **NO** incluyen I.V.A.-Esta lista sustituye a las anteriores-Sujetos a cambios sin previo aviso.

La información e imágenes contenidas pueden sufrir cambios sin previo aviso, por motivos de actualización y mejora continua sin responsabilidad alguna por la marca o su publicidad

EX-MA

(2.0 X 2.0 M)



INCLUYE LADO 1

108-RM	24-RM	45-BEA
20-RCC	24-T	45-BRA
20-RPC	24-TD	45-CF
23-CRE	24-TH	JE-02C
23-IR	34-MC	JE-04C
23-MCC	34-MCC	JE-90C
23-MTC	34-MCO	JE-91C
23-MTL	34-MT	
23-PR	37-MPL	
23-RDG	44-AR	
23-RI	44-DCB	
23-TM	44-DRB	
23-TMO	44-F	
24-BT	44-N	
24-CC	44-PH	
24-IP	44-PO	
24-IR	44-T	
24-MC	44-WG	
24-ML	45-BA	
24-MP	45-BAI	
24-MTL	45-BC	

LADO 1

*IMAGEN REPRESENTATIVA



INCLUYE LADO 2

004-FM	8-BM
109-FM	8-BT
44-AC	8-CR
44-AM	8-D
44-BC	8-IC
44-DCA	8-IE
44-G	8-IGN
44-GA	8-IP
44-GP	8-IPF
44-R	8-MF
44-TRC	8-ST
45-BA	JE-20C
45-BAI	JE-94C
45-BC	JE-96C
45-BEA	JE-99C
45-BRA	
45-CF	
45-F	
6-LC	
7-LC	
7-MC	

LADO 2

*IMAGEN REPRESENTATIVA

PRECIO
COTIZAR
DISPONIBLE EN CEREZO-OYAMEL

Estos precios **NO** incluyen I.V.A.-Esta lista sustituye a las anteriores-Sujetos a cambios sin previo aviso.
La información e imágenes contenidas pueden sufrir cambios sin previo aviso, por motivos de actualización y mejora continua sin responsabilidad alguna por la marca o su publicidad

EX-MA1

(1.0 X 1.80 M)



LADO 1

*IMAGEN REPRESENTATIVA



LADO 2

*IMAGEN REPRESENTATIVA

INCLUYE LADO 1

- | | | |
|--------|--------|--------|
| 109-FM | 45-BA | 8-D |
| 34-MC | 45-BEA | 8-I |
| 34-MCC | 45-BRA | 8-IC |
| 34-MCO | 45-F | 8-IGN |
| 34-MT | 6-LC | 8-IP |
| 44-AM | 7-LC | 8-IPF |
| 44-DCB | 7-MC | JE-02C |
| 44-DRB | 8-BT | JE-90C |
| 44-GS | 8-CR | |

INCLUYE LADO 2

- | | | |
|--------|--------|--------|
| 23-MTC | 24-MP | 44-TRC |
| 23-PR | 24-MTL | 45-BAI |
| 23-RDG | 24-T | 45-BC |
| 23-RI | 24-TD | 45-CF |
| 23-TLS | 24-TH | CHME |
| 24-BT | 24-TP | JE-99C |
| 24-CC | 44-AR | JE-94C |
| 24-CRB | 44-F | MCME |
| 24-IG | 44-G | MCRE |
| 24-IP | 44-N | RI-53 |
| 24-MC | 44-PH | |

PRECIO

COTIZAR

DISPOIBLE EN CEREZO-OYAMEL

EX-CR1



PRECIO

COTIZAR

EX-M1



INCLUYE

- 2 MEZCLADORAS P/ LAVABO
2 MEZCLADORA P/ FREGADERO

PRECIO

COTIZAR

EX-M2



INCLUYE

- 3 MEZCLADORAS P/ LAVABO
1 MEZCLADORA P/ FREGADERO

PRECIO

COTIZAR

Estos precios **NO** incluyen I.V.A.-Esta lista sustituye a las anteriores-Sujetos a cambios sin previo aviso.

La información e imágenes contenidas pueden sufrir cambios sin previo aviso, por motivos de actualización y mejora continua sin responsabilidad alguna por la marca o su publicidad

EX-AG

(0.80 X 2.20 M)



LADO 1

LADO 2

*IMAGEN REPRESENTATIVA

INCLUYE LADO 1

- JE-02C
- JE-33C
- JE-90C
- JE-91C
- JE-96C
- JE-99C

INCLUYE LADO 2

- GA-700 JE-90C
- JE-04C JE-94C
- JE-108 PR-700
- JE-220 PV-700
- JE-260 TA-700
- JE-303 TB-700
- JE-502
- JE-606
- JE-700

PRECIO

COTIZAR

DISPONIBLE EN COLOR MADERA

EXT

TARJAS
(0.95 X 2.0 M)



*IMAGEN REPRESENTATIVA

INCLUYE

- 9-DT
- 9-ED
- 9-TSE

PRECIO

COTIZAR

DISPONIBLE EN COLOR MADERA

EX-CP1

(0.50 X 1.70 M)



*IMAGEN REPRESENTATIVA

INCLUYE

- 1 PZA: 100-I
- 1 PZA: 25-BHH
- 1 PZA: 25-BMH
- 1 PZA: 25-GN
- 1 PZA: 26-FR
- 1 PZA: 4-N
- 1 PZA: CPI-06
- 1 PZA: CTI

PRECIO

COTIZAR

ARTICULO SOLO DE EXHIBICIÓN

EX-CER

(0.46 X 0.55 M)



*IMAGEN REPRESENTATIVA

INCLUYE

- 1 PZA: CEB
- 1 PZA: CECO (CDL+CEL)
- 1 PZA: CEDL
- 1 PZA: CEL
- 1 PZA: CEP

PRECIO

COTIZAR

Estos precios **NO** incluyen I.V.A.-Esta lista sustituye a las anteriores-Sujetos a cambios sin previo aviso.

La información e imágenes contenidas pueden sufrir cambios sin previo aviso, por motivos de actualización y mejora continua sin responsabilidad alguna por la marca o su publicidad

EX-RA

(0.28 X 0.71 M)



*IMAGEN REPRESENTATIVA

INCLUYE

- 46-AF
- 46-AR
- 46-P
- 47-CZ
- 47-P

PRECIO
COTIZAR

EX-CR

(0.46 X 0.55 M)



*IMAGEN REPRESENTATIVA

KIT-CA

(0.46 X 0.55 M)

NOTA: ESTE EXHIBIDOR SE VENDE SIN CARTUCHOS

PRECIO
COTIZAR

C/5 CARTUCHOS DE C/U

INCLUYE

- | | |
|-------|-------|
| B98 | R36MM |
| B98CC | RB71E |
| B98CE | RB72E |
| B98E | RB73C |
| B98EE | RB73F |
| B98IN | RB73L |
| B98N | RB79E |
| BRI02 | RC36C |
| BRI98 | RI36C |
| R34MC | |
| R34MQ | |

PRECIO
COTIZAR

EX-M

(0.60 X 0.65 M)



*IMAGEN REPRESENTATIVA

INCLUYE

- | | |
|--------|--------|
| 23-CRE | 45-BAI |
| 24-IP | 45-CF |
| 24-T | 8-I |
| 38-I | 8-IP |
| 44-AR | MCRE |
| 44-N | |
| 44-PH | |
| 44-WG | |

PRECIO
COTIZAR
DISPONIBLE EN CEREZO-OYAMEL

EX-16S

(0.23 X 0.68 M)



*IMAGEN REPRESENTATIVA

INCLUYE

- 16-SE

PRECIO
COTIZAR

Estos precios **NO** incluyen I.V.A.-Esta lista sustituye a las anteriores-Sujetos a cambios sin previo aviso.

La información e imágenes contenidas pueden sufrir cambios sin previo aviso, por motivos de actualización y mejora continua sin responsabilidad alguna por la marca o su publicidad



RUGO[®]
Calidad en Válvulas

Más que una **marca...**
toda una **tradición.**

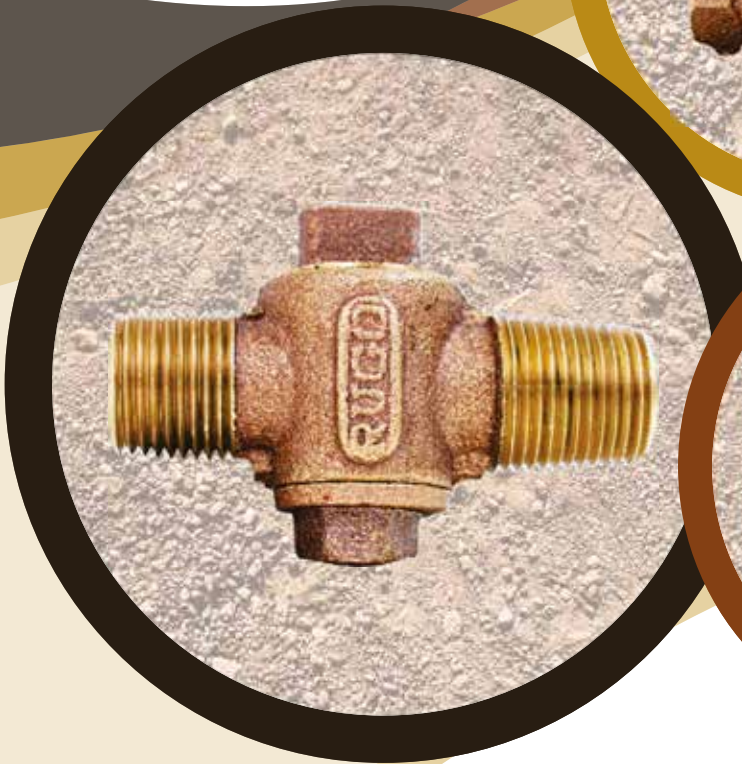

Toma Domiciliaria



NOM
NOM-001-CONAGUA-2011

www.rugo.com.mx

TOMA DOMICILIARIA TUBO DE PE-AL-PE

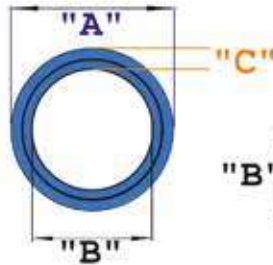

TUBO	MEDIDA "A" EXTERIOR	MEDIDA "B" INTERIOR	MEDIDA "C" GROSOR
1/2"	16 mm	12 mm	2 mm
5/8"	20 mm	16 mm	2 mm
3/4"	25 mm	20 mm	2.5 mm

FIG.	MEDIDA	MASTER	PRECIO
TPAP	1/2"		\$3,318.94
	5/8"	1	\$4,524.39
	3/4"		\$7,435.18

ESPECIFICACIONES TÉCNICAS

FIGURA	TPAP (ROLLO DE 100 M)
DESCRIPCIÓN	TUBO MULTICAPA PE-AL-PE
SERVICIOS	AGUA
APLICACIÓN	TOMA DOMICILIARIA, PLOMERIA
MEDIDAS NOMINALES	1/2" (13mm) 5/8" (16mm) 3/4" (19mm)
MATERIAL CAPA EXTERIOR	POLIETILENO
MATERIAL CAPA INTERMEDIA	ALUMINIO
MATERIAL CAPA INTERIOR	POLIETILENO

ESPECIFICACIONES TÉCNICAS

PRESIÓN MAX. DE TRABAJO	20 Kg/cm ² A 20° C
PRESIÓN MIN. DE REVENTAMIENTO	1/2" (13mm) 60Kg/cm ² A 23° C
	5/8" (16mm) 50Kg/cm ² A 23° C
	3/4" (19mm) 40Kg/cm ² A 23° C
PESO APROX. ROLLO (100 m)	1/2" (13mm) 9.72Kg
	5/8" (16mm) 12.65Kg
	3/4" (19mm) 20.90Kg

ABRAZADERA



- Para tubo de P.V.C. y polietileno
- Material de bronce

FIGURA	ESPECIFICACIÓN	CONT. MASTER	PRECIO UNITARIO
99-AB	DE 3" CONEX. 1/2"	25	\$535.84
	DE 3" CONEX. 3/4"		\$733.24
	DE 3" CONEX. 3/4" ROSCA MÜLLER		\$730.86



- Multi diámetro
- Material de bronce

FIGURA	ESPECIFICACIÓN	CONT. MASTER	PRECIO UNITARIO
99-AB	DE 4" CONEX. 1/2"	25	\$971.32
	DE 4" CONEX. 3/4"	25	\$971.32
	DE 4" CONEX. 3/4" ROSCA MÜLLER	20	\$971.32
	DE 6" CONEX. 1/2"	20	\$1,806.59
	DE 6" CONEX. 3/4"	20	\$1,806.59
	DE 6" CONEX. 3/4" ROSCA MÜLLER	20	\$1,806.59
	DE 6" CONEX. 1"	20	\$1,806.59
	DE 8" CONEX. 1/2"	20	\$2,179.93
	DE 8" CONEX. 3/4"	20	\$2,179.93
	DE 8" CONEX. 3/4" ROSCA MÜLLER	20	\$2,179.93
	DE 8" CONEX. 1"	20	\$2,179.93



- Multi diámetro
- Material de bronce
- Abrazadera reforzada

FIGURA	ESPECIFICACIÓN	CONT. MASTER	PRECIO UNITARIO
99-ABR	DE 4" CONEXIÓN 1/2"	25	\$1,116.86
	DE 4" CONEXIÓN 3/4"	25	\$1,120.02



Estos precios **NO** incluyen I.V.A.-Esta lista sustituye a las anteriores-Sujetos a cambios sin previo aviso.

La información e imágenes contenidas pueden sufrir cambios sin previo aviso, por motivos de actualización y mejora continua sin responsabilidad alguna por la marca o su publicidad

VÁLVULA DE INSERCIÓN

VÁLVULA



- Presión de 150 lbs/ pulg² (10.54 kgs / cm²)
- Material de bronce

NOM APLICA SÓLO PARA 1/2" Y 3/4" 

FIG.	MEDIDA	CONT. MTR	PRECIO UNIT.
	1/2"(13 mm)	100	\$354.36
76	3/4"(19 mm)	50	\$547.36
	1"(25 mm)	x	\$1,362.02

VÁLVULA PARA POLIDUCTO DE ALTA DENSIDAD



- Presión de 150 lbs/ pulg² (10.54 kgs / cm²)
- Material de bronce



FIG.	MEDIDA	CONT. MTR	PRECIO UNIT.
	1/2"(13 mm)	50	\$376.50
80-B	3/4"(19 mm)	50	\$686.57

VÁLVULA PARA POLIDUCTO DE BAJA DENSIDAD



- Presión de 150 lbs/ pulg² (10.54 kgs / cm²)
- Material de bronce



FIG.	MEDIDA	CONT. MTR	PRECIO UNIT.
80-E	1/2"(13 mm)	100	\$332.21

VÁLVULA PARA TUBO DE COBRE



- Presión de 150 lbs/ pulg² (10.54 kgs / cm²)
- Material de bronce
- Sistema de compresión

NOM APLICA SÓLO PARA 1/2" Y 3/4" 

FIG.	ESPECIFICACIÓN	MEDIDA	CONT. MTR.	P.UNIT.
	P/tubo con diámetro exterior .625=5/8" NTP	1/2"(13 mm)	60	\$398.65
81	P/tubo C/diámetro ext. .750=3/4" MÜLLER	3/4"(19 mm)	50	\$686.57
	P/ tubo con diámetro exterior .875=7/8" NTP	7/8"(22 mm)	50	\$686.57

VÁLVULA PARA TUBO DE COBRE



- Presión de 150 lbs/ pulg² (10.54 kgs / cm²)
- Material de bronce
- Sistema de compresión



FIG.	MEDIDA	CONT. MTR	PRECIO UNIT.
81-EC	1/2"(13 mm)	50	\$528.37
	3/4"(19 mm)	75	\$813.12

VÁLVULA PARA TUBO DE PE-AL-PE



- Presión de 150 lbs/ pulg² (10.54 kgs / cm²)
- Material de bronce



FIG.	MEDIDA	CONT. MTR	PRECIO UNIT.
81-EP	1/2"(13 mm)	50	\$525.21
	3/4"(19 mm)	50	\$753.01

VÁLVULA DE ESFERA PARA TUBO DE POLIETILENO



- Presión de 150 lbs/ pulg² (10.54 kgs / cm²)
- Material de bronce
- Sistema de compresión
- Con tuerca abrazadera



FIG.	MEDIDA	CONT. MTR	PRECIO UNIT.
81-ETA	1/2"(13 mm)	100	\$547.36
	3/4"(19 mm)	100	\$784.65

VÁLVULA PARA TUBO DE PE-AL-PE



- Presión de 150 lbs/ pulg² (10.54 kgs / cm²)
- Material de bronce



FIG.	MEDIDA	CONT. MTR	PRECIO UNIT.
81-P	1/2"(13 mm)	50	\$408.14
	3/4"(19 mm)	50	\$572.67

VÁLVULA PARA TUBO DE POLIETILENO



- Presión de 150 lbs/ pulg² (10.54 kgs / cm²)
- Material de bronce
- Sistema de compresión
- Con tuerca abrazadera

FIG.	ESPECIFICACIÓN	MEDIDA	CONT. MTR.	P.UNIT.
	Con diámetro exterior 5/8"	1/2"(13 mm)	60	\$658.09
81-PTA	Con diámetro ext. 21.3	1/2"(13 mm)	50	\$461.93
	Con diámetro exterior 7/8"	3/4"(19 mm)	50	\$689.73

Estos precios **NO** incluyen I.V.A.-Esta lista sustituye a las anteriores-Sujetos a cambios sin previo aviso.

La información e imágenes contenidas pueden sufrir cambios sin previo aviso, por motivos de actualización y mejora continua sin responsabilidad alguna por la marca o su publicidad

NUDO PARA TUBO DE COBRE



- Presión de 150 lbs/ pulg² (10.54 kgs / cm²)
- Material de bronce
- Sistema de compresión

NOM APLICA SÓLO PARA 1/2" Y 3/4"



FIG.	ESPECIFICACIÓN	MEDIDA	CONT. MTR.	P.UNIT.
	P/tubo con diámetro exterior .625=5/8"	1/2"(13 mm)	200	\$170.85
81-A	P/tubo C/diámetro ext. .750=3/4"	3/4"(19 mm)	75	\$240.46
	P/ tubo con diámetro exterior .875=7/8"	7/8"(22 mm)	75	\$240.46

NUDO PARA TUBO DE PE-AL-PE



- Presión de 150 lbs/ pulg² (10.54 kgs / cm²)
- Material de bronce



FIG.	MEDIDA	CONT. MTR.	PRECIO UNIT.
81-AP	1/2"(13 mm)	250	\$123.39
	3/4"(19 mm)	150	\$199.33

NUDO PARA TUBO DE PE-AL-PE



- Presión de 150 lbs/ pulg² (10.54 kgs / cm²)
- Material de latón

FIG.	MEDIDA	CONT. MTR.	PRECIO UNIT.
81-APL	1/2"(13 mm)	500	\$88.94



NUDO HEMBRA PARA TUBO DE PE-AL-PE

- Presión de 150 lbs/ pulg² (10.54 kgs / cm²)
- Material de bronce



FIG.	MEDIDA	CONT. MTR.	PRECIO UNIT.
81-HP	1/2"(13 mm)	250	\$121.81
	3/4"(19 mm)	150	\$193.00

NUDO HEMBRA PARA TUBO DE PE-AL-PE



- Presión de 150 lbs/ pulg² (10.54 kgs / cm²)
- Material de latón

FIG.	MEDIDA	CONT. MTR.	PRECIO UNIT.
81-HPL	1/2"(13 mm)	100	\$97.83



NUDO PARA TUBO DE POLIETILENO

- Presión de 150 lbs/ pulg² (10.54 kgs / cm²)
- Material de bronce
- Sistema de compresión
- Con tuerca abrazadera



FIG.	MEDIDA	CONT. MTR.	PRECIO UNIT.
81-LTA	1/2"(13 mm)	200	\$291.08

NUDO PARA TUBO DE COBRE



- Presión de 150 lbs/ pulg² (10.54 kgs / cm²)
- Material de bronce
- Sistema de compresión



FIG.	MEDIDA	CONT. MTR.	PRECIO UNIT.
81-ML	1/2"(13 mm)	10	\$182.94



NUDO PARA TUBO COBRE Ó POLIETILENO

- Presión de 150 lbs/ pulg² (10.54 kgs / cm²)
- Material de bronce
- Sistema de compresión
- Con tuerca abrazadera



FIG.	MEDIDA	CONT. MTR.	PRECIO UNIT.
81-MTA	1/2"(13 mm)	200	\$291.08

NUDO HEMBRA PARA TUBO DE POLIETILENO



- Presión de 150 lbs/ pulg² (10.54 kgs / cm²)
- Material de bronce
- Sistema de compresión



FIG.	MEDIDA	CONT. MTR.	PRECIO UNIT.
81-PHS	3/4"(19 mm)	x	\$268.93



NUDO MACHO PARA TUBO POLIETILENO

- Presión de 150 lbs/ pulg² (10.54 kgs / cm²)
- Material de bronce
- Sistema de compresión



FIG.	MEDIDA	CONT. MTR.	PRECIO UNIT.
81-PMS	3/4"(19 mm)	x	\$291.08

Estos precios **NO** incluyen I.V.A.-Esta lista sustituye a las anteriores-Sujetos a cambios sin previo aviso.

La información e imágenes contenidas pueden sufrir cambios sin previo aviso, por motivos de actualización y mejora continua sin responsabilidad alguna por la marca o su publicidad

INSERTORES

INSERTO PARA POLIDUCTO DE BAJA DENSIDAD

- Presión de 142 lbs/ pulg² (10 kgs / cm²)
- Material de bronce



FIG.	MEDIDA	CONT.	MTR	PRECIO UNIT.
	1/2"(13 mm)	500		\$71.69
94-B	3/4"(19 mm)	300		\$120.23
	1"(25 mm)	150		\$208.82
B94-B	1/2" (13 mm)	100		\$74.86
	3/4"(19 mm)	100		\$123.39

INSERTO PARA POLIDUCTO DE BAJA DENSIDAD

- Presión de 142 lbs/ pulg² (10 kgs / cm²)
- Material de latón



FIG.	MEDIDA	CONT.	MTR	PRECIO UNIT.
	1/2"(13 mm)	500		\$48.09
94-BL	3/4"(19 mm)	300		\$82.26
	1"(25 mm)	125		\$147.44

INSERTO HEMBRA P/POLIDUCTO BAJA DENSIDAD

- Presión de 142 lbs/ pulg² (10 kgs / cm²)
- Material de bronce



FIG.	MEDIDA	CONT.	MTR	PRECIO UNIT.
94-BH	3/4"(19 mm)	250		\$142.38

INSERTO PARA POLIDUCTO

- Presión de 142 lbs/ pulg² (10 kgs / cm²)
- Material de bronce
- Con tuerca de ajuste



FIG.	MEDIDA	CONT.	MTR	PRECIO UNIT.
	1/2"(13 mm)	100		\$158.20
96-A	3/4"(19 mm)	150		\$249.95

INSERTO PARA POLIDUCTO

- Presión de 142 lbs/ pulg² (10 kgs / cm²)
- Material de bronce
- Con tuerca de ajuste. rosca muller



FIG.	MEDIDA	CONT.	MTR	PRECIO UNIT.
	1/2"(13 mm)	100		\$158.20
96-AM	3/4"(19 mm)	100		\$249.95

VÁLVULAS

VÁLVULA ESFERA

- Presión de 142 lbs/ pulg² (10 kgs / cm²)
- Material de bronce
- Roscada



FIG.	MEDIDA	CONT.	MTR	PRECIO UNIT.
100-IB	1/2"(13 mm)	x		\$427.13

VÁLVULA EXPULSORA

- Presión de aire
- Material de latón



FIG.	MEDIDA	CONT.	MTR	PRECIO UNIT.
101	1/2"(13 mm)	100		\$240.46

VÁLVULA GLOBO ANGULAR

- Cierre de compresión
- Material de bronce



FIG.	MEDIDA	CONT.	MTR	PRECIO UNIT.
73-A	1/2"(13 mm)	50		\$224.64

VÁLVULA MACHO MANGO T

- Presión de 142 lbs/ pulg² (10 kgs / cm²)
- Material de bronce
- Roscada



NOM APLICA SÓLO PARA 1/2" Y 3/4"

FIG.	MEDIDA	CONT.	MTR	PRECIO UNIT.
	1/2"(13 mm)	100		\$370.18
82	3/4"(19 mm)	50		\$591.65
	1"(25mm)	42		\$721.37

Estos precios **NO** incluyen I.V.A.-Esta lista sustituye a las anteriores-Sujetos a cambios sin previo aviso.

La información e imágenes contenidas pueden sufrir cambios sin previo aviso, por motivos de actualización y mejora continua sin responsabilidad alguna por la marca o su publicidad

VÁLVULAS

VÁLVULA MACHO MANGO CUADRO



- Presión de 142 lbs/ pulg² (10 kgs / cm²)
- Material de bronce
- Roscada



NOM APLICA SÓLO PARA 1/2" Y 3/4"

FIG.	MEDIDA	CONT. MTR	PRECIO UNIT.
83	1/2"(13 mm)	75	\$341.24
	3/4"(19 mm)	50	\$471.42
	1"(25 mm)	25	\$588.49
	1 1/2"(38 mm)	15	\$2,416.83
	2" (51 MM)	10	\$3,761.88
B-83	1/2"(13 mm)	100	\$302.69
	3/4"(19 mm)	50	\$503.21

VÁLVULA LIMITADORA



- Conexión roscada
- Material de bronce



FIG.	MEDIDA	CONT. MTR	PRECIO UNIT.
84-BR	1/2"(13 mm)	100	\$563.18

VÁLVULA LIMITADORA



- Conexión roscada
- Material de bronce



FIG.	MEDIDA	CONT. MTR	PRECIO UNIT.
84-BRN	1/2"(13 mm)	100	\$531.54



VÁLVULA LIMITADORA

- Conexión roscada
- Material de latón



EL CORTE O REGULACIÓN DE FLUJO CON ORIFICIO PARA SELLO ANTI-VIOLATORIO

FIG.	MEDIDA	CONT. MTR	PRECIO UNIT.
84-LR	1/2"(13 mm)	100	\$287.54

VÁLVULA MACHO PARA CANDADO



- Presión de 142 lbs/ pulg² (10 kgs / cm²)
- Material de bronce
- Roscada



NOM APLICA SÓLO PARA 1/2" Y 3/4"

FIG.	MEDIDA	CONT. MTR	PRECIO UNIT.
86	1/2"(13 mm)	100	\$329.71
	3/4"(19 mm)	75	\$534.70
	1"(25 mm)	50	\$790.98



VÁLVULA MACHO PARA CANDADO CON OREJAS

- Presión de 142 lbs/ pulg² (10 kgs / cm²)
- Material de bronce
- Roscada



FIG.	MEDIDA	CONT. MTR	PRECIO UNIT.
86-DA	1/2"(13 mm)	100	\$348.03

VÁLVULA DE BANQUETA



- Presión de 142 lbs/ pulg² (10 kgs / cm²)
- Material de bronce
- Fierro-fierro



FIG.	MEDIDA	CONT. MTR	PRECIO UNIT.
87-L	1/2"(13 mm)	75	\$322.72
	3/4"(19 mm)	50	\$724.53



VÁLVULA DE BANQUETA

- Presión de 142 lbs/ pulg² (10 kgs / cm²)
- Material de bronce
- Fierro-cobre
- Sistema de compresión



FIG.	ESPECIFICACIÓN	MEDIDA	CONT. MTR.	P.UNIT.
89-L	P/tubo con diámetro exterior .625=5/8"	1/2"(13 mm)	50	\$381.25
	P/tubo C/diámetro ext. .750=7/8"	3/4"(19 mm)	25	\$699.22

VÁLVULA DE BANQUETA



- Presión de 142 lbs/ pulg² (10 kgs / cm²)
- Material de bronce
- Fierro-fierro
- Sistema de compresión
- Con tuerca abrazadera



FIG.	MEDIDA	CONT. MTR	P. UNIT.
89-LTA	1/2" CØ EXT. 5/8" (13 mm)	100	\$382.83
	1/2" CØ EXT. 21.3 mm	50	\$471.42
	3/4" CØ EXT. 7/8" (22.2 mm)	25	\$787.81



VÁLVULA DE BANQUETA

- Presión de 142 lbs/ pulg² (10 kgs / cm²)
- Material de bronce
- Fierro-poliducto

NOM APLICA SÓLO PARA 1/2"



FIG.	MEDIDA	CONT. MTR	PRECIO UNIT.
90-D	1/2"(13 mm)	50	\$522.04
	3/4"(19 mm)	50	\$889.06

Estos precios **NO** incluyen I.V.A.-Esta lista sustituye a las anteriores-Sujetos a cambios sin previo aviso.

La información e imágenes contenidas pueden sufrir cambios sin previo aviso, por motivos de actualización y mejora continua sin responsabilidad alguna por la marca o su publicidad

VÁLVULAS

VÁLVULA DE BANQUETA



- Presión de 142 lbs/ pulg² (10 kgs / cm²)
- Material de bronce
- Fierro-PE-AL-PE



FIG.	MEDIDA	CONT. MTR	PRECIO UNIT.
90-P	1/2"(13 mm)	100	\$512.55

VÁLVULA DE BANQUETA



- Presión de 142 lbs/ pulg² (10 kgs / cm²)
- Material de bronce
- Cobre-cobre
- Sistema de compresión



FIG.	ESPECIFICACIÓN	MEDIDA	CONT. MTR.	P.UNIT.
91-L	P/tubo con diámetro exterior .625=5/8"	1/2"(13 mm)	50	\$601.14
	P/tubo C/diámetro ext. .750=7/8"	3/4"(19 mm)	50	\$734.03

VÁLVULA DE BANQUETA



- Presión de 142 lbs/ pulg² (10 kgs / cm²)
- Material de bronce
- Sistema de compresión
- P/tubo de polietileno c/tuerca abrazadera



FIG.	ESPECIFICACIÓN	MEDIDA	CONT. MTR.	P.UNIT.
91-LTA	P/tubo con diámetro exterior .625=5/8"	1/2"(13 mm)	50	\$699.22
	P/tubo C/diámetro ext. .750=7/8"	3/4"(19 mm)	50	\$876.40

VÁLVULA DE BANQUETA



- Presión de 142 lbs/ pulg² (10 kgs / cm²)
- Material de bronce
- PE-AL-PE



FIG.	MEDIDA	CONT. MTR	PRECIO UNIT.
91-P	1/2"(13 mm)	100	\$536.28

MANERAL VÁLVULA LIMITADORA

- Material estriado
- Material de acero inoxidable



FIG.	CONT. MTR	PRECIO UNIT.
M-84L	25	\$376.50

COPLE DE REPARACIÓN



- Cople unión para tubo de cobre
- Material de bronce
- Sistema de compresión



FIG.	ESPECIFICACIÓN	CONT. MTR.	P.UNIT.
81-U	P/tubo con diámetro exterior .625=5/8"	100	\$192.14
	P/tubo C/diámetro ext. .750=3/4"	75	\$296.36
	P/ tubo con diámetro exterior .875=7/8"	75	\$296.36
	P/ tubo con diámetro exterior .1000=1"	50	\$442.95
B81-U	P/ tubo con diámetro exterior .625=5/8"	50	\$198.47
	P/ tubo con diámetro exterior .875 = 22 mm	50	\$302.69

- Cople unión para poliducto de alta densidad
- Material de bronce



FIG.	MEDIDA	CONT. MTR	PRECIO UNIT.
81-UAD	1/2"(13 mm)	100	\$332.21
	3/4"(19 mm)	100	\$386.00



- Cople unión para tubo de PE-AL-PE
- Material de latón



FIG.	MEDIDA	CONT. MTR	PRECIO UNIT.
81-UAL	1/2"(13 mm)	300	\$145.54



- Cople unión para tubo de PE-AL-PE
- Material de bronce

NOM APLICA SÓLO PARA 1/2"



FIG.	MEDIDA	CONT. MTR	PRECIO UNIT.
81-UAP	13 mm	250	\$155.03
	19 mm	100	\$325.88

Estos precios **NO** incluyen I.V.A.-Esta lista sustituye a las anteriores-Sujetos a cambios sin previo aviso.

La información e imágenes contenidas pueden sufrir cambios sin previo aviso, por motivos de actualización y mejora continua sin responsabilidad alguna por la marca o su publicidad

COPLE DE REPARACIÓN



- Cople de unión para tubo de cobre
- Material de latón
- Sistema de compresión

FIG.	ESPECIFICACIÓN	CONT. MTR.	P.UNIT.
81-UL	sist. de compr. 13 mm p/tubo c/diá. ext. .625=5/8"	96	\$161.36



- Cople unión para poliducto de alta densidad
- Material de bronce
- Sistema de compresión

FIG.	MEDIDA	CONT. MTR.	PRECIO UNIT.
81-UPP	3/4"(19 mm)	100	\$458.77



- Cople unión para poliducto de alta densidad
- Material de bronce
- Sistema de compresión

FIG.	ESPECIFICACIÓN	MEDIDA	CONT. MTR.	P.UNIT.
81-UTL	Sist. de compr. 13 mm para tubo c/diámetro exterior .625=5/8"	13 mm	100	\$268.93
		19 mm	100	\$383.35
		22 mm	50	\$408.14



NOM APLICA SÓLO
PARA 1/2" Y 3/4"

CODOS COMBINADOS

- Fierro-poliducto
- Material de bronce



FIG.	MEDIDA	CONT. MTR.	PRECIO UNIT.
96-B	1/2"(13 mm)	100	\$177.18
	3/4"(19 mm)	50	\$319.55



- Fierro-cobre
- Material de bronce
- Para tubo con diámetro exterior .625=5/8"



FIG.	MEDIDA	CONT. MTR.	PRECIO UNIT.
96-C	1/2"(13 mm)	150	\$188.25



- Fierro-cobre
- Material de bronce
- Tuerca con abrazadera
- Para tubo con diámetro exterior .625=5/8"



FIG.	MEDIDA	CONT. MTR.	PRECIO UNIT.
96-CTA	1/2"(13 mm)	50	\$262.60



- Fierro de PE-AL-PE
- Material de bronce



FIG.	MEDIDA	CONT. MTR.	PRECIO UNIT.
96-PF	1/2"(13 mm)	150	\$202.36



- Fierro de PE-AL-PE
- Material de latón



FIG.	MEDIDA	CONT. MTR.	PRECIO UNIT.
96-PFL	1/2"(13 mm)	200	\$170.85

- Fierro-polietileno
- Material de bronce



FIG.	MEDIDA	CONT. MTR.	PRECIO UNIT.
96-PH	3/4"(19 mm)	100	\$405.30



Estos precios **NO** incluyen I.V.A.-Esta lista sustituye a las anteriores-Sujetos a cambios sin previo aviso.
La información e imágenes contenidas pueden sufrir cambios sin previo aviso, por motivos de actualización y mejora continua sin responsabilidad alguna por la marca o su publicidad

CODOS COMBINADOS

- Fierro-polietileno
- Material de bronce



FIG. 96-PM MEDIDA 3/4" (19 mm) CONT. MTR 100 PRECIO UNIT. \$390.74

- Polietileno-polietileno
- Material de bronce



FIG. 96-PP MEDIDA 3/4" (19 mm) CONT. MTR 70 PRECIO UNIT. \$534.70

NIPLE Y COMPLEMENTOS

NIPLE UNIÓN

- Material de bronce



FIGURA 97-N MEDIDA 1/2" (13 mm) x 1/2" (13 mm) CONT. MTR 500 P. UNIT. \$62.80

NIPLE REDUCCIÓN

- Material de bronce



FIGURA 97-NR MEDIDA 3/4" (19 mm) x 1/2" (13 mm) CONT. MTR 500 P. UNIT. \$93.59

REDUCCIÓN BUSHING

- Material de bronce



FIGURA 97-RB MEDIDA 3/4" (19 mm) x 1/2" (13 mm) CONT. MTR 30 P. UNIT. \$93.90

TAPÓN MACHO

- Material de bronce



FIGURA 97-TM MEDIDA 1/2" (13 mm) CONT. MTR 500 P. UNIT. \$45.88

TAPÓN MACHO

- Para prueba de hermeticidad en toma domiciliar



FIGURA 97-TPH MEDIDA 3/4" (19 mm) CONT. MTR 250 P. UNIT. \$104.92

NIPLE CAMPANA

- Material de bronce



FIGURA NC MEDIDA 3/4" (19 mm) x 3/4" (19 mm) CONT. MTR 150 P. UNIT. \$123.39

NIPLE CAJA MEDIDOR

- Material de bronce



FIGURA NCM01 MEDIDA 1/2" (13 mm) CONT. MTR X P. UNIT. \$295.83

NIPLE MEDIDOR

- Material de bronce



FIGURA NMR MEDIDA 3/4" A 1/2" CONT. MTR x P. UNIT. \$144.02

NIPLE MEDIDOR

- Con tuerca
- Material de bronce



FIGURA NMT MEDIDA NIPLE 1/2" X 1 5/8" LONG TUERCA 3/4" CONT. MTR 250 P. UNIT. \$147.75

NIPLE MEDIDOR

- Con tuerca
- Material de bronce

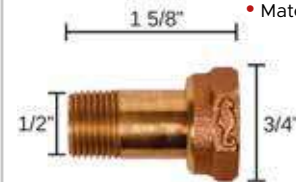

FIGURA NMT MEDIDA NIPLE 1/2" X 1 5/8" LONG TUERCA 1" CONT. MTR 200 P. UNIT. \$205.65

NIPLE MEDIDOR

- Con tuerca
- Material de bronce



FIGURA NMT MEDIDA NIPLE 3/4" X 2" LONG TUERCA 1" CONT. MTR 100 P. UNIT. \$268.93
 NMT MEDIDA NIPLE 3/4" X 2 1/2" LONG TUERCA 1" CONT. MTR 100 P. UNIT. \$322.72
 NMT MEDIDA NIPLE 3/4" X 3" LONG TUERCA 1" CONT. MTR 100 P. UNIT. \$341.70

Estos precios **NO** incluyen I.V.A.-Esta lista sustituye a las anteriores-Sujetos a cambios sin previo aviso.

La información e imágenes contenidas pueden sufrir cambios sin previo aviso, por motivos de actualización y mejora continua sin responsabilidad alguna por la marca o su publicidad

NIPLE Y COMPLEMENTOS

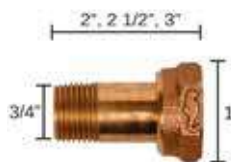
NIPLE CAMPANA

- Material de bronce



FIGURA NC
MEDIDA 3/4" A 1/2"
CONT. MTR X
P. UNIT. \$110.74

NIPLE CAJA MEDIDOR

- Material de bronce



FIGURA NCM01
MEDIDA 1/2"
CONT. MTR X
P. UNIT. \$295.83

NIPLE MEDIDOR

- Reducido



FIGURA NMR
MEDIDA 3/4" A 1/2"
CONT. MTR X
P. UNIT. \$144.02

PRODUCTO NUEVO

VÁLVULA

- Válvula de inserción p/cuello de cobre



FIGURA 76-A
MEDIDA 3/4" 1"
CONT. MTR X
P. UNIT. \$521.24 \$1,139.00

NUDO DE INSERCIÓN

- Para tubo de polipropileno, con empaque ranurado.



FIGURA 81-AR
MEDIDA 7/8"
CONT. MTR X
P. UNIT. \$240.46

VÁLVULA

- Válvula de inserción rosca muller p/tubo de polipropileno, c/empaque ranurado



FIGURA 81-RM
MEDIDA 7/8"
CONT. MTR X
P. UNIT. \$686.57

TAPÓN

- Con empaque ranurado



FIGURA 97-THR
MEDIDA 7/8"
CONT. MTR X
P. UNIT. \$104.92

CUELLO

- Cuello de cobre



FIGURA CC
MEDIDA 1"
CONT. MTR X
P. UNIT. \$1,087.74

CONEXIÓN

- Conexión especial cobre a cobre 20 cm de longitud



FIGURA CCE
MEDIDA 3/4" 7/8"
CONT. MTR X
P. UNIT. \$622.39 \$622.39

PIE DOBLE

- Pie de cobre sencillo doble



FIGURA PIE-TD
MEDIDA 3/4"
CONT. MTR X
P. UNIT. \$1,435.17

PIE

- Pie de cobre sencillo



FIGURA PIE-TD
MEDIDA 1/2" 3/4" 1"
CONT. MTR X
P. UNIT. \$828.25 \$1,172.44 \$1,204.78

TUERCA CÓNICA

- Para tubo de cobre con empaque
- Material de bronce



FIGURA TC
MEDIDA 13 mm 19 mm 22 mm 25 mm
CONT. MTR 300
P. UNIT. \$74.95 \$113.93 \$129.31 \$170.85

TUERCA CÓNICA

- Para tubo de cobre con empaque ranurado



FIGURA TCR
MEDIDA 7/8"
CONT. MTR X
P. UNIT. \$115.28

TEE DUPLEX

- Con tuerca y empaque para tubo de plástico



FIGURA TEE-DP
MEDIDA 3/4"
CONT. MTR X
P. UNIT. \$340.25

TEE DUPLEX

- Con tuerca y empaque para tubo de cobre



FIGURA TEE-DC
MEDIDA 3/4"
CONT. MTR X
P. UNIT. \$410.30

Estos precios **NO** incluyen I.V.A.-Esta lista sustituye a las anteriores-Sujetos a cambios sin previo aviso.

La información e imágenes contenidas pueden sufrir cambios sin previo aviso, por motivos de actualización y mejora continua sin responsabilidad alguna por la marca o su publicidad



RUGO®

Calidad en Válvulas



- **PLANTA**
AV. LOS ÁNGELES 1005 OTE.
COL. FUTURO NOGALAR
SAN NICOLÁS DE LOS GARZA
NUEVO LEÓN, MÉXICO C.P. 66484
E-mail: rugo@rugo.com.mx
- **CORPORATIVO**
AV. LOS ÁNGELES 3009 OTE.
COL. IND BENITO JUÁREZ
MONTERREY N.L. MÉXICO C.P. 64517
TEL. (81) 8865-8150
FAX. (81) 8865-8162
E-mail: rugo@rugo.com.mx
- **SUCURSAL GUADALAJARA**
CALZADA GONZÁLEZ GALLO
No. 515 COL. LAS CONCHAS
GUADALAJARA, JALISCO,
MÉXICO C.P. 44460
TEL. (33) 3619-0679
FAX. (33) 3619-1792
E-mail: rugogdl@rugo.com.mx
- **SUCURSAL MÉXICO**
PONIENTE 140 #671 BODEGA "B"
COL. INDUSTRIAL VALLEJO
DEL. AZCAPOTZALCO C.P. 02300
MÉXICO, D.F.
TEL. (55) 1661-0466
FAX. (55) 1661-0465

